

USER MANUAL

Rackmount FERRUPS

FES/FER/QFES/QFER 850VA-7kVA



FERRUPS®

Rackmount Uninterruptible Power Systems
FES, FER, QFES, or QFER 850VA to 7kVA

USER MANUAL

FSS-0348C



Listed Models Available

IMPORTANT SAFETY INSTRUCTIONS

SAVE THESE INSTRUCTIONS — This manual contains important instructions for your UPS.

How to Use This Manual

Your FERRUPS is very easy to start and operate. This manual tells you how to start, operate and communicate with your FERRUPS and how to get more information for special situations. Begin with Section 100 to find the startup section for your model.

IF YOUR FERRUPS IS SOUNDING AN ALARM, and you need to know what the alarm means and how to respond, turn to [Section 304](#) on page 14.

The installation and use of this product must comply with all national, federal, state, municipal, or local codes that apply. If you need help, please call Best Power's Worldwide Service at 1-800-356-5737 (U.S. or Canada) or 1-608-565-2100, or call the nearest Best Power office. Please have your UPS' serial number available when you call. Best Power's international and domestic offices are listed below.

FERRUPS SERIAL NUMBER: _____

North America

Best Power
P.O. Box 280
Necedah, Wisconsin 54646 U.S.A.
Telephone: 1-608-565-7200 or
1-800-356-5794 (U.S.A. and Canada)
FAX: 1-608-565-2221
International FAX: 1-608-565-7675

Best Power Worldwide Service
P.O. Box 11
Necedah, WI 54646 U.S.A.
Telephone: 1-800-356-5737 (U.S.A. and Canada)
1-608-565-2100
FAX: 1-608-565-2509
International FAX: 1-608-565-2799

Best Power Technology Mexico, S.A. de C.V.
Golfo de Riga, 34
Colonia Tacuba
Mexico D.F. 11410
MEXICO
Telephone: (52)(5) 399-0369
FAX: (52)(5) 399-1320

Asia

Best Power Technology Pte. Ltd.
PICO Creative Centre, Level 5
20 Kallang Avenue
SINGAPORE 339411
Telephone: 65-2938122
FAX: 65-2968766

Europe

Best Power Technology Limited
BEST House
Wykeham Industrial Estate
Moorside Road
Winchester
Hampshire
SO23 7RX
ENGLAND
Telephone: (44) 1962-844414
Toll-Free: 0800-378444 (England)
FAX: (44) 1962-841846

Best Power Technology GmbH
Am Weichselgarten 23
D-91058 Erlangen
GERMANY
Telephone: +49/9131/77700
Toll-Free: 0130/84/7712 (Germany)
FAX: +49/9131/777050

Borri Elettronica Industriale Srl
Via dei Lavoratori, 124
20092 CINISELLO BALSAMO (Mi)
Milan, ITALY
Telephone: (39) 2-6600661-2
FAX: (39) 2-6122481

Best Power Technology AG
Limmatstrasse 12
8957 Spreitenbach
SWITZERLAND
Telephone: 056/418-30-30
FAX: 056/418-30-33

Australia

Sola Australia Ltd.
13 Healey Road
Dandenong Victoria 3175
AUSTRALIA
Telephone: 61-3-9706-5022
FAX: 61-3-9794-9150

Table of Contents

Introduction	1
001 If You Have a Problem or a Question	1
002 If You Need More Information	1
Section 100: Identifying Your FERRUPS	2
Section 200: Startup	3
201 Storing your FERRUPS	3
202 Startup: FES and QFES 850VA to 2.1kVA and FER and QFER 1.8kVA to 3.1kVA	3
203 Startup: FER and QFER 4.3kVA and 7kVA	6
Section 300: Operation	10
301 Front Panel Lights	10
302 How to Use the Control Panel	11
303 Automatic System Test	14
 304 ALARMS: What They Mean, What to Do about Them	14
305 Parameter Table	16
306 How to Read the Alarm and Inverter Logs	19
307 If You Have an Extended Power Outage	21
308 How (and When) to Shut Down Your FERRUPS	21
Section 400: Communications	23
401 Connecting a Terminal or Computer to the RS232 Port	24
402 Entering Commands from a Terminal or Computer	26
403 Remote Monitoring and Remote Shutdown	29
Section 500: Maintenance and Service	30
501 Regular Maintenance	30
502 Service and Support	30
Section 600: Specifications	31
601 Specification Table: Standard Product	31
602 AC Output with Nominal Input Power and Loads (Protected Equipment)	32
603 Lightning and Surge Protection	32
604 Isolation and Noise Rejection	32
605 Environment	32
606 Protection	33
607 Batteries and Battery Charger	33
608 Dimensions and Weights	34
Section 700: Warranty	35
Section 800: Options	37

Introduction

Welcome to the growing FERRUPS family. FERRUPS represents a breakthrough in the design of advanced, on-line uninterruptible power systems.

Please read this manual thoroughly before operating your FERRUPS. Keep this manual handy for future reference.

001 If You Have a Problem or a Question

Best Power is committed to outstanding customer service. Our Worldwide Service center is happy to help you with any problems or answer any questions you may have. Service technicians are available 24 hours a day, 365 days a year. Just call the telephone number below or your [nearest Best Power office](#), or send a fax to the Worldwide Service fax number. Please have your serial number available when you call.

If you prefer to contact Best Power via computer, bulletin board service and CompuServe are available, and Best Power has a World Wide Web site with more product information.

Best Power's toll-free Fax on Demand service is available 24 hours a day to give you access to technical notes and product information.

Worldwide Service	1-800-356-5737 (U.S.A. and Canada) or 1-608-565-2100
Worldwide Service Fax:	1-608-565-2509
BBS:	1-608-565-7424
CompuServe:	Go BEST at any ! prompt.
World Wide Web Site:	http://www.bestpower.com
Fax on Demand:	1-800-487-6813

002 If You Need More Information

This manual provides the information you need for basic operation of your FERRUPS. If you have a special application or if you need more in-depth information, Best Power offers an excellent selection of literature to help you, including Service Manuals with complete technical information and guidelines. Simply call your local [Best Power office](#). We'll be happy to meet your information needs promptly.

Section 100: Identifying Your FERRUPS

All rackmount models need some installation before startup, so please make sure you have installed your FERRUPS before you go on. (See the Installation Manual.) Then, use the drawings below to find the startup section for your model.

850VA-3.1kVA.
Go to [Section 202](#).

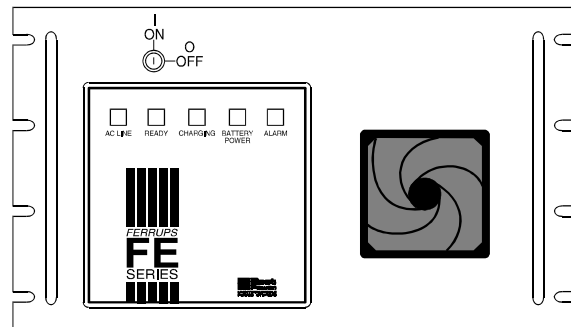

4.3kVA and 7kVA.
Go to [Section 203](#).

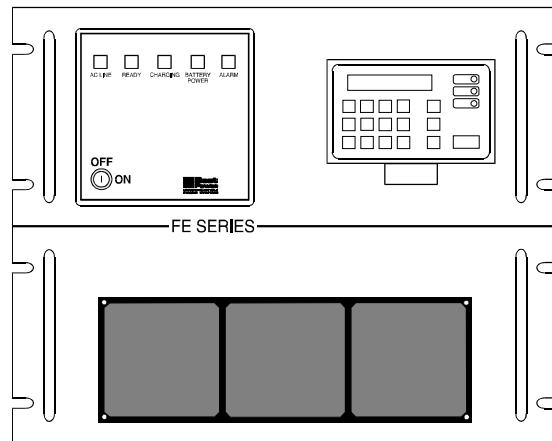

Section 200: Startup

This section provides step-by-step instructions for starting your FERRUPS. We'll explain how to turn on DC and AC power and how to prepare the UPS to support your equipment.

201 Storing Your FERRUPS

If you do not plan to use your FERRUPS right away, you must store it between -20° and $+40^{\circ}$ Celsius (-4° to $+104^{\circ}$ Fahrenheit). If you remove the batteries and store them separately, you can store the UPS itself at -20° to $+60^{\circ}$ C (-4° to $+140^{\circ}$ F). **Keep batteries in storage fully charged. Recharge the batteries every 90-120 days. Batteries will have a longer shelf life if you store them below 77° F (25° C).**

202 Startup: FES and QFES 850VA to 2.1kVA, and FER and QFER 1.8kVA to 3.1kVA

Make sure the temperature is 0° to 40° Celsius (32° to 104° Fahrenheit). The relative humidity must be 0-95% without condensation. The air must be free of dust, chemicals that corrode, or other contaminants, and the air must be free to move around FERRUPS.

Back View

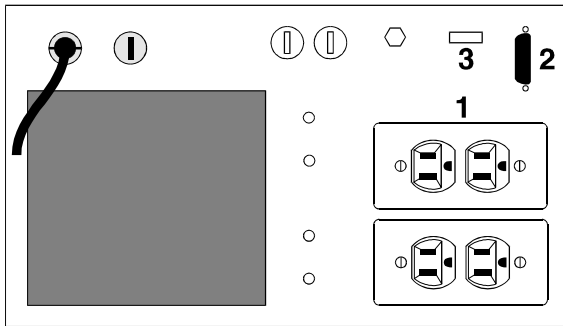

850VA to 1.4kVA

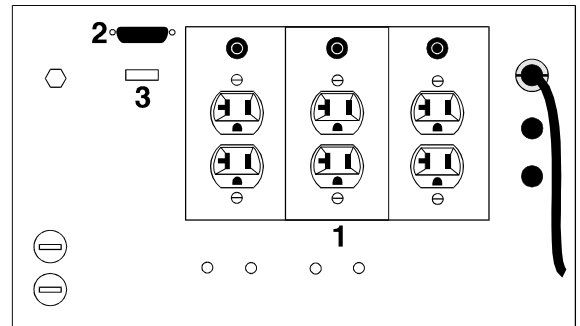

1.8kVA to 3.1kVA

- 1 = Optional Output Receptacles (for your equipment)
- 2 = RS232 Communication Port
- 3 = Alarm Silence Switch

 **CAUTION**

To avoid possible equipment damage or personal injury, assume that FERRUPS terminals or receptacles may have AC voltage present any time AC input voltage or DC battery voltage is supplied. FERRUPS can provide output voltage from its batteries even when there is no AC input voltage. When AC input voltage is present, FERRUPS can provide output voltage even when its batteries are disconnected. Always disconnect the AC input source to make sure there will be no UPS output voltage; if you have a separate battery cabinet, you must also shut off the battery cabinet's DC switch or disconnect the battery cabinet from the UPS. To reduce the risk of electric shock, install the UPS in a temperature-controlled indoor area free of conductive contaminants.

1 Turn off the equipment you want the FERRUPS to protect.

2 *If your FERRUPS is a plug-in model:* Plug in the UPS. Once you have plugged in the FERRUPS, the AC LINE light should light. If the plug and your outlet (receptacle) do not match, ask your electrician to install the outlet you need.

Note: 230-volt models do not include a power cord. To plug in these models, follow these steps:

- a) If the equipment you want to protect has a detachable power cord, disconnect the cord from this equipment. (You will use another cord to connect your equipment in step 5.)

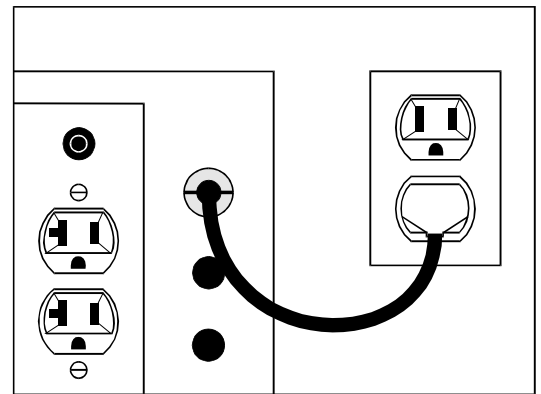

If your equipment does not have a detachable power cord, call the nearest [Best Power office](#) to order a power cord.

- b) Use the cord to plug in the UPS. (Connect the UPS end of the cord first.)

If the FERRUPS is not a plug-in model: your electrician should have installed your UPS and connected your protected equipment using the Installation Manual. Turn the AC Disconnect switch on.

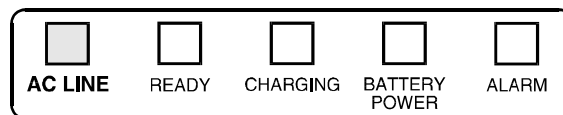

3 If you have a separate battery cabinet, remove the bolts that hold the front of your cabinet to the rack. Then, slide the cabinet slightly out of the rack. If there is a hinged panel on top, remove the screw in the panel, open it, and turn on the DC switch. Then, close the panel and reattach the screw. Slide the cabinet back into the rack, and use the bolts to attach the front of the cabinet to the rack.

- 4 Use the FERRUPS key to turn the On/Off (I/O) switch on. After a short startup test, the green READY light should blink for a few seconds and then stay lit.

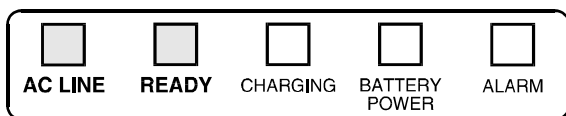

The CHARGING light may be on at this point; this means FERRUPS' batteries are not fully charged, and FERRUPS is charging them now. FERRUPS automatically charges the batteries whenever the AC LINE light is on and the BATTERY POWER light is off. The CHARGING light will turn off when the batteries have been fully charged. This may take 24 hours. FERRUPS' runtime (battery backup time) will be shorter until the batteries have been charged.

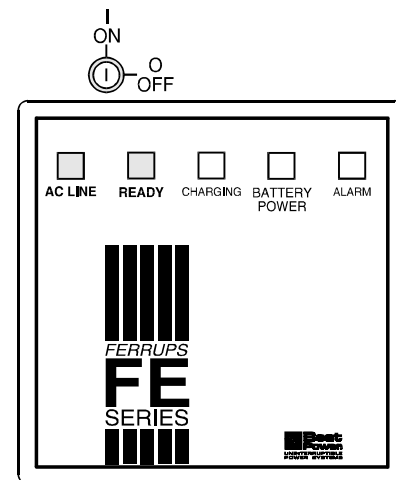

- 5 *If your FERRUPS has receptacles on the back:* Plug the equipment you want to protect into the UPS' receptacles. (If you have a 50 Hz model, use the cord or plug provided to connect your equipment to FERRUPS' receptacles.) Next, switch on your equipment. **If the red Alarm light comes on, see Section 304 on page 14.**

If your FERRUPS does not have receptacles on the back: Turn the bypass switch to "UPS." Then, switch on the equipment that is connected to your FERRUPS. **If the red Alarm light comes on, see Section 304 on page 14.**

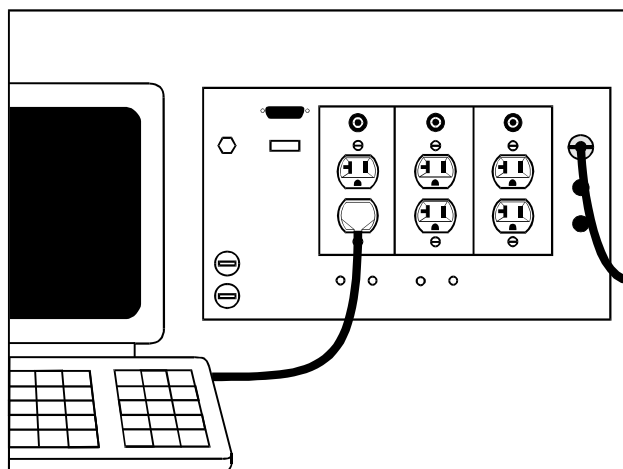

- 6 **Fill out the Warranty Registration Card in this manual** and return it to Best Power. This card helps Best Power's Worldwide Service when your FERRUPS needs routine maintenance or if there is a problem.

Your FERRUPS includes free CheckUPS II Suite power management software. The CheckUPS II Suite monitors power conditions; during a long power outage, CheckUPS II automatically shuts down your computer system just before the FERRUPS runs out of battery power. See the instructions that came with the CheckUPS II Suite package.

That's it! Your FERRUPS is now providing conditioned, computer-grade power to your equipment, and FERRUPS is ready to provide power from its batteries if AC input power goes bad.

When the FERRUPS operating mode changes, FERRUPS will bring it to your attention. For example, when FERRUPS runs on battery power, the yellow Battery Power light comes on and FERRUPS beeps a few times each minute. When there is a FERRUPS alarm, the red Alarm light comes on and FERRUPS sounds the Morse code for the alarm.

See the rest of this manual for information on operation, communication, and alarms.

203 Startup: FER and QFER 4.3kVA and 7kVA

Make sure the temperature is 0° to 40° Celsius (32° to 104° Fahrenheit). The relative humidity must be 0-95% without condensation. The air must be free of dust, chemicals that corrode, or other contaminants, and the air must be free to move around FERRUPS.

FERRUPS Features

Front Panel Lights (LEDs)

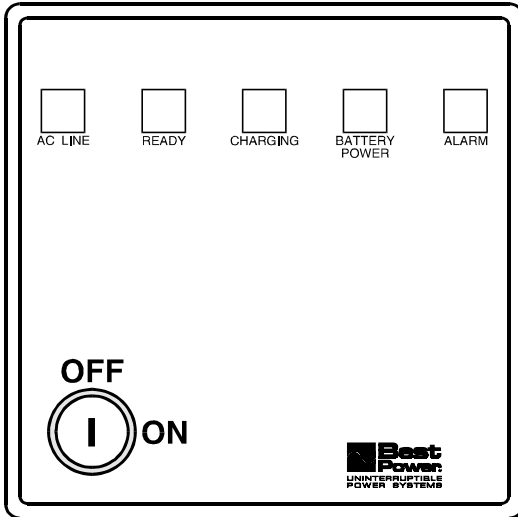

Control Panel

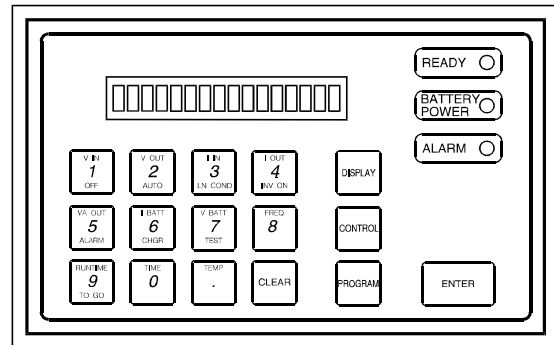

Back View

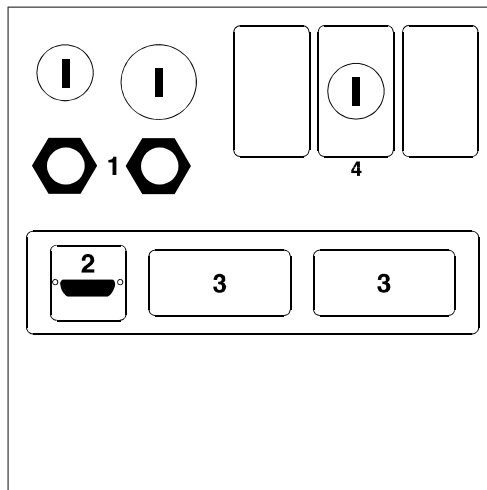

- 1 = Input for Battery Cables (DC Cables)
- 2 = RS232 Communication Port
- 3 = Optional Circuit Breaker Panels
- 4 = Output Receptacle Panel (Optional)

CAUTION

To avoid possible equipment damage or personal injury, assume that FERRUPS' terminals or receptacles may have AC voltage present any time AC input voltage or DC battery voltage is supplied. FERRUPS can provide output voltage from its batteries even when there is no AC input voltage. When AC input voltage is present, FERRUPS can provide output voltage even when its batteries are disconnected. Always disconnect the AC input source AND turn the DC switch Off (or disconnect the battery connector) to make sure there is no UPS output voltage. (See [Section 308.](#)) To reduce the risk of electric shock, install the UPS in a temperature-controlled indoor area free of conductive contaminants.

1 Turn off the equipment you want the FERRUPS to protect.

2 If your FERRUPS is not a plug-in model, your electrician should have installed your UPS and connected your protected equipment using the Installation Manual. Make sure your AC Disconnect Switch and the UPS On/Off switch are both off.

If your FERRUPS is a plug-in model, make sure the AC input power is off at the service panel. Then, plug in the UPS. If the plug and your outlet (receptacle) do not match, ask your electrician to install the receptacle you need.

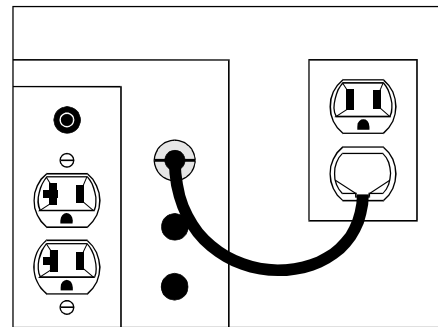

3 There are two types of battery cabinets: one type has a connector on the back for connecting battery cables, and the other simply has openings for the cables. If your cabinet has a battery connector, go on to step 4. If not, follow the instructions below.

First, remove the bolts that hold the cabinet to the front of your rack. Next, slide the cabinet out until you can see a hinged panel on the top of the battery cabinet. Remove the screw in the panel and lift it to find the DC switch; turn this switch on. Now, close the panel and tighten the screw that holds it in place. Slide the cabinet back into your rack, and tighten the bolts that attach the cabinet to the front of your rack. If you have more than one battery cabinet, make sure you turn on the DC Switch for each cabinet.

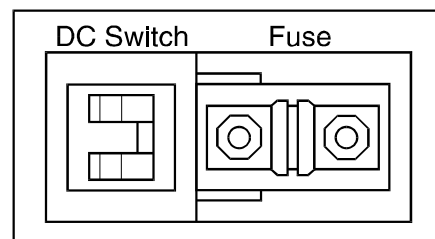

4 To start FERRUPS on battery power, use the key to turn the On/Off switch on. After a brief self-check, the yellow BATTERY POWER light and the green READY light will light on the UPS and the control panel. The UPS will beep every 20 seconds to let you know it is running on battery power (inverter). The control panel will show the BEST logo; press the [ENTER] key to continue. Now, the control panel will scroll this display:

FERRUPS by BEST
Mode: Auto
Charger: Off
Beeper: Enabled

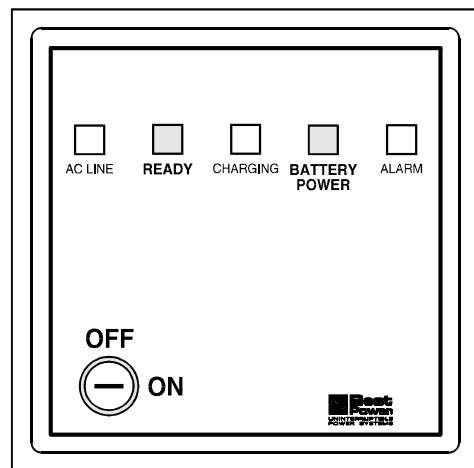

If the red ALARM light is on, read the alarm message on the control panel display, turn off the On/Off keyswitch and the DC switch(es), and call Best Power's Worldwide Service at 1-800-356-5737 (U.S. and Canada) or 1-608-565-2100, or call the nearest [Best Power office](#).

5 If your FERRUPS does not have a plug, it has a bypass switch mounted nearby. Turn the UPS AC Line Disconnect Switch on. The green AC LINE light will light. After a few seconds, FERRUPS will switch from battery power (inverter) to AC input power. The BATTERY POWER light should turn off. Now, turn the UPS Bypass Switch to “UPS.”

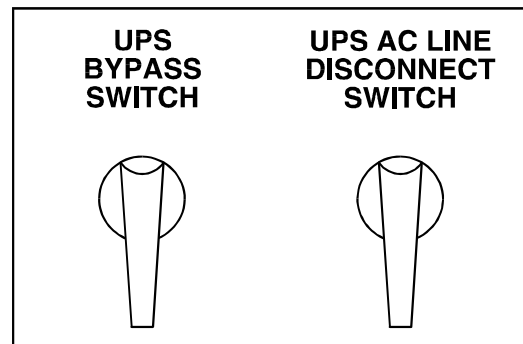

If your FERRUPS has a plug, turn the AC input power on at the service panel. The green AC LINE light will light. After a few seconds, FERRUPS will switch from battery power (inverter) to AC input power. The BATTERY POWER light should turn off.

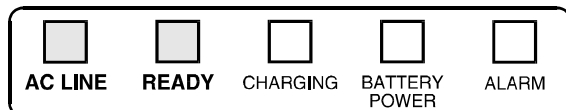

The CHARGING light may be on at this point; this means FERRUPS’ batteries are not fully charged, and FERRUPS is charging them now. FERRUPS automatically charges the batteries whenever the AC LINE light is on and the BATTERY POWER light is off. The CHARGING light will turn off when the batteries have been fully charged. This may take 24 hours. FERRUPS’ runtime (battery backup time) will be shorter until the batteries have been charged.

6 *If your FERRUPS does not have receptacles on the back:*
Switch on the equipment connected to your FERRUPS. **If the red Alarm light comes on, see Section 304 on page 14.**

If your FERRUPS has receptacles on the back:
Plug the equipment you want to protect into the UPS receptacles. Then, switch on your equipment. **If the red Alarm light comes on, see Section 304 on page 14.**

7 Now, you can set the time and date using the control panel. FERRUPS needs the correct time and date for its Alarm and Inverter Logs, so you should reset the time and date whenever FERRUPS has been shut down. First, you need to enter the User password (377). This password lets you change some FERRUPS parameters.

<u>PRESS THIS KEY:</u>	<u>DISPLAY SHOWS:</u>
[CLEAR]	FERRUPS by BEST
[PROGRAM]	Password:
[3][7][7]	Password: 377
[ENTER]	Level: User

Time is parameter 0; see Section 305 for more information on parameters. To set the time, follow these steps:

<u>PRESS THIS KEY:</u>	<u>DISPLAY SHOWS:</u>
[DISPLAY]	Display:
[0]	Display: 0
[ENTER]	00 Time: 11:30:20
[PROGRAM]	00 Pgm:

Enter the correct time using the 24-hour system. To do this, you enter times from 1:00 a.m. to 12:59 p.m. just as you would read them from a clock. From 1:00 p.m. to 11:59, however, you add 12 hours to the “clock time.” So 8:30 a.m. would be entered [8] [3] [0], but 8:30 p.m. would be entered [2] [0] [3] [0]. Midnight is [0] [0] [0] [0], 12:30 a.m. is [0] [0] [3] [0], and so on. For example, if the time is 9:30 a.m.:

<u>PRESS THIS KEY:</u>	<u>DISPLAY SHOWS:</u>
[9][3][0]	00 Pgm: 930
[ENTER]	00 Time 09:30:00

Set the date next. The date is parameter 10. To display the date, press these keys:

<u>PRESS THIS KEY:</u>	<u>DISPLAY SHOWS:</u>
[DISPLAY]	Display:
[1][0]	Display: 10
[ENTER]	10 Date: 01/01/96
[PROGRAM]	10 Pgm:

Now, press the number of the month, then the number of the day of the month, and then the year. For example, to enter June 14, 1996:

<u>PRESS THIS KEY:</u>	<u>DISPLAY SHOWS:</u>
[0] [6] [1] [4] [9] [6]	10 Pgm: 061496
[ENTER]	10 Date 06/14/96

Now that you’ve entered the time and date, clear the password by pressing the [CLEAR] key twice (until you see the message “Password Cleared” on the control panel display.)

8 Please fill out the Warranty Registration Card in this manual and return it to Best Power. This card helps Best Power’s Worldwide Service when your FERRUPS needs routine maintenance or if there is a problem.

Your FERRUPS includes free CheckUPS II Suite power management software. CheckUPS II monitors power conditions; during a long power outage, CheckUPS II automatically shuts down your computer system just before the FERRUPS runs out of battery power. See the instructions that came with the CheckUPS II Suite package.

That’s it! Your FERRUPS is now providing conditioned, computer-grade power to your equipment, and FERRUPS is ready to provide power from its batteries if AC input power goes bad.

When the operating mode changes, FERRUPS will bring it to your attention. For example, when FERRUPS runs on battery power, the yellow Battery Power light comes on and FERRUPS beeps a few times each minute. When there is a FERRUPS alarm, the red Alarm light comes on and FERRUPS sounds the Morse code for the alarm.

See the rest of this manual for information on operation, communication, and alarms.

Section 300: Operation

This section will describe how FERRUPS works. We'll discuss the meaning of the front panel lights and describe how to use the control panel. We'll also describe what the automatic system test does, what each alarm means, what parameters do, and how to read the Alarm and Inverter Logs. Finally, we'll see how to turn off FERRUPS.

301 Front Panel Lights

At the front of your FERRUPS is a panel with five lights (LEDs). These lights tell you several things about the operating status of the FERRUPS.

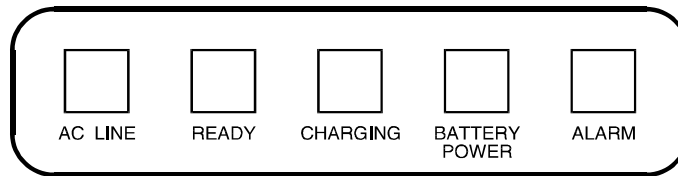

Light (LED)	Color	What It Means When It's ON	What It Means When It's OFF	What It Means When It Blinks
AC LINE	Green	FERRUPS is getting power from the AC input power source.	FERRUPS is not getting input power; there is an outage, the AC input breaker is tripped, or you have unplugged the UPS.	Not applicable.
READY	Green	FERRUPS is ready to provide backup power from its batteries when needed.	FERRUPS cannot provide backup power; it may be in the Line Condition Mode or the Off Mode (see Section 302), or its batteries may be discharged, or it may be running on battery power (Inverter On mode).	You have just started the UPS; the UPS is testing the batteries as part of the automatic system test (see Section 303); or, you have started a timed shutdown (Section 402).
CHARGING	Green	FERRUPS is charging the batteries.	The battery charger is off; batteries are at full charge.	Not applicable.
BATTERY POWER	Yellow	FERRUPS is providing power from its batteries; it is in the Inverter Mode.	FERRUPS is providing conditioned power from the AC input power source, or FERRUPS is off.	FERRUPS is testing the inverter as part of the automatic system test. (See Section 303 .)
ALARM	Red	FERRUPS is warning you that an alarm exists. If you have not silenced the alarm beeper, you should be hearing a code that tells you what the problem is. (See Section 304 .) If you have a control panel, an alarm message appears on its display.	No alarm exists.	Not applicable.

302 How to Use the Control Panel

The control panel comes with all FER and QFER 4.3kVA and 7kVA models. If you have an 850VA to 3.1kVA rackmount model, you may have ordered the control panel as an option. If you have, please see TIP 407 to connect the control panel.

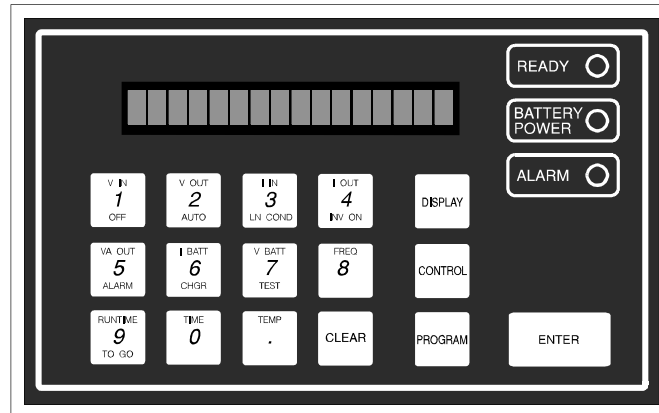

The control panel is attached to the front of 4.3 and 7 kVA models with a six-foot (1.8-meter) cable, which lets you pick up the control panel and hold it in your hand. The panel's READY, BATTERY POWER and ALARM lights work like the READY, BATTERY POWER and ALARM lights on the front of the UPS. (See [Section 301](#).)

You can use the control panel to change FERRUPS system modes and display and change parameters. You can also lock the control panel and change some of its features. If you press the wrong key at any time, press [CLEAR] and then the correct key. The control panel will click each time you press a key.

How to Change Operating Modes:

There are four UPS operating modes: Auto, Inverter On (Battery Power), Line Condition, and Off. FERRUPS will select the appropriate operating mode automatically; however, occasionally you may need to set the operating mode manually from the control panel. Notice that the names of the operating modes appear in red on the bottom of keys 1-4.

Operating Mode	How to Select It	What It Means
Off	Press [CONTROL] [1] [ENTER] [ENTER].	FERRUPS is not providing power to your equipment, but you can still use the control panel. The READY light is off.
Auto	Press [CONTROL] [2] [ENTER] [ENTER].	This is the normal operating mode. FERRUPS conditions AC input power and provides this conditioned power to your equipment, and it is ready to switch to battery power if necessary. The AC LINE and READY lights should be on.
Line Condition	Press [CONTROL] [3] [ENTER] [ENTER].	FERRUPS is conditioning AC input power and providing this conditioned power to your equipment, but if there is a brownout or power outage, FERRUPS will not switch to battery power. Instead, the UPS will shut down its output until AC input power is available again. The READY light is off when FERRUPS is in this mode.
Inverter On (Battery Power)	Press [CONTROL] [4] [ENTER] [ENTER].	FERRUPS converts battery power to AC power for your equipment. It will not charge the batteries. The BATTERY POWER light is on. The UPS calculates the runtime remaining and sounds an alarm when runtime starts to get low.

How to Enter Passwords

Before you can change some parameter values, you must enter a password. (The instructions below describe how to display and change parameters.) You must also enter a password before you enter some of the commands listed in [Section 402](#).

Note: When you first receive your UPS, you do not need to enter a password before you enter some commands. If you change parameter 39 to “Yes,” you must enter a User password before you can:

- use [CONTROL] key functions like the ones that change system modes, or
- use some commands. (See [Section 402](#).)

The User Password is 377. If you need a higher level password, call Best Power’s Worldwide Service. To enter the User password, follow these steps:

<u>PRESS THIS KEY:</u>	<u>DISPLAY SHOWS:</u>
[CLEAR]	FERRUPS by BEST
[PROGRAM]	Password:
[3] [7] [7]	Password: 377
[ENTER]	Level: User

When you want to clear the password, press the [CLEAR] key until you see “Password Cleared” on the control panel display.

How to Display and Change Parameters

To display a parameter press [DISPLAY], the parameter number, and [ENTER]. (The names of the first 11 parameters appear in green on the top of the number keys.) For example, to display parameter 0 (time), follow these steps:

<u>PRESS THIS KEY:</u>	<u>DISPLAY SHOWS:</u>
[DISPLAY]	Display:
[0]	Display: 0
[ENTER]	00 Time 07:04:08

To change a parameter, display it first. Then, press [PROGRAM], enter the new value you want for the parameter, and press [ENTER]. (You will need a password to change most parameters.) For example, to change parameter 0 (time), follow these steps:

<u>PRESS THIS KEY:</u>	<u>DISPLAY SHOWS:</u>
[DISPLAY] [0] [ENTER]	00 Time 07:04:08
[PROGRAM]	00 Pgm:
[9] [3] [0]	00 Pgm: 930
[ENTER]	00 Time 09:30:00

How to Lock and Unlock the Control Panel

You may need to disable (lock) your control panel if you want to limit its use. When you disable the control panel, it will not respond to its keys until you enable it again. To disable the panel, press the keys shown below. (Make sure you have the Unlock number shown below.)

<u>PRESS THESE KEYS:</u> [CLEAR] and [ENTER] together	<u>DISPLAY READS:</u> -Keypad Locked-
--	--

When you lock the control panel, it will beep and show the display above for about two seconds; the control panel will beep and show this display whenever you try to use the keys. The front panel lights (LEDs) will continue to show the UPS' status, and the control panel will show UPS alarms. To enable the control panel again,

<u>PRESS THESE KEYS:</u> [CLEAR] and [ENTER] together [8] [2] [0] [4] [9] [ENTER]	<u>DISPLAY READS:</u> Unlock #: Unlock #: 82049 Keypad Unlocked
--	--

After about two seconds, the control panel will show the same display it showed before you unlocked it. If you enter the wrong Unlock number, the control panel will display "-Keypad Locked-" for two seconds, and the control panel will remain locked.

How to Use the Configuration Menu

Your control panel includes a Configuration Menu that lets you adjust its baud rate and brightness, turn the beeper on or off, turn off the click you hear when you press keys, and control other features. The label on the back of your control panel includes more information on this menu. (See the drawing below.)

Remote Control Panel (RCP)
Access Instructions for Configuration Menu

Simultaneously press [CONTROL] and [PROGRAM] to enter RCP Configuration menu

At any time: Press [ENTER] to display/edit next menu item
Press [PROGRAM] to exit menu and save changes
Press [CLEAR] to exit menu without saving changes

Menu Item	Range	Notes
Baud Rate	0 - 5	0=300, 1=1200, 2=2400, 3=4800, 4=9600, 5=19200
Brightness	0 - 7	Display brightness: 0=Min, 7=Max
Beeper	0 - 1	Beeper enabled? 0=No, 1=Yes
Keyclick	0 - 1	Keyclick enabled? 0=No, 1=Yes
Repeat	0 - 1	Autorepeat of depressed key? 0=No, 1=Yes
Connect	0 - 1	Send "123DCP" at startup? 0=No, 1=Yes

303 Automatic System Test

FERRUPS regularly tests its memory, batteries, and inverter to make sure they will perform when you need them. (The factory setting for the time between tests is seven days.) During the system test, the BATTERY POWER and READY lights will blink. For the results of the last system test, you can display parameter 26. (See [Section 305](#).)

Logic Test: First, FERRUPS checks its memory. If it finds a problem, the UPS sounds alarm O, Memory Check (- - -). (See [Section 304](#).)

Inverter Test: The inverter converts DC battery power into the AC power your equipment uses. During the Inverter Test, FERRUPS pulses its inverter to see if it delivers the proper amount of current. If not, FERRUPS sounds alarm N, “Check Inverter” (- ●). (See [Section 304](#).) Although it is testing the inverter, FERRUPS is not in “Inverter Mode”; it continues to condition input power, and it is ready to provide battery power if there is a power outage. The BATTERY POWER light will blink during this part of the test.

Battery Test: FERRUPS also checks its batteries to make sure that they can support your equipment for the minimum specified runtime. If not, FERRUPS sounds alarm M, “Check Battery” (- -). (See [Section 304](#).) The READY light will blink during this part of the test.

304 ALARMS: What They Mean, What to Do about Them

When FERRUPS detects a problem, it

- sounds an alarm code,
- lights up the red ALARM light on the front panel (and the control panel if you have one), and
- displays an error message on the control panel (if you have one). (If the control panel does not display the message, press [CLEAR] until you reach the scrolling display.)

Here’s how you should react:

1. Find out which alarm FERRUPS is sounding. If you have a control panel, you can read the alarm on the display. If you do not have a control panel, listen to the FERRUPS alarm code; FERRUPS will sound the Morse Code for the alarm letter. (See the alarm table on the next two pages to match the code to a letter.)
2. Find the alarm in the table on the next two pages. This table will tell you what the alarm means and how to react to it. If the table tells you to call [Best Power](#), call the nearest Best Power office. (You can call Worldwide Service at 1-608-565-2100; in the U.S. and Canada, call 1-800-356-5737.)
3. If you want to silence the alarm beep, follow the instructions below.

850VA to 3.1kVA: Turn off the Alarm Silence Switch on the back of your FERRUPS.

4.3kVA and 7kVA: Press [CONTROL] [5] [ENTER] [ENTER] on the control panel.

Remember to turn the alarm beep back on after you’ve corrected the problem that caused the alarm. If you forget to do this, FERRUPS will not be able to sound an alarm code the next time there is an alarm. (FERRUPS will still show a red ALARM light and flash an alarm message on the control panel display.)

Letter	Audio Code	Alarm Message	What It Means	What To Do
A	● -	Low Battery	The battery charge is low because the system was running on battery power, or the DC Switch is not on.	The UPS will shut down. Before this alarm, you should have received a "Low Runtime" alarm (- ● ●) to warn you to shut down your equipment. When AC power returns, turn FERRUPS on again. The green CHARGING LED should light as the batteries recharge.
B	- ● ● ●	Near Low Battery	The battery voltage has reached the Near Low Battery setpoint.	The alarm should clear itself when the battery charger has charged the batteries enough.
C	- ● - ●	High Battery	There may be a problem with the charging circuit or parameter settings.	Phone Best Power's Worldwide Service
D	- ● ●	Low Runtime	The unit is running on battery power, and the battery runtime remaining is low.	Do an orderly shutdown of your equipment. Then turn FERRUPS off to conserve battery power. When AC input power returns, turn FERRUPS on again.
E	●	Low AC Output	The output voltage is below a preprogrammed setpoint.	The UPS will shut down. Shut down your equipment or bypass the UPS, and turn the UPS switch off. Phone Best Power's Worldwide Service .
F	● ● - ●	High AC Output	The output voltage is higher than the alarm setting.	Phone Best Power's Worldwide Service .
G	-- ●	Output Overload	Your equipment is drawing more volt-amps (power) than the UPS can provide. (See your model's VA rating.) The unit will continue to run with overloads as high as 125% for 10 minutes and then shut down.	Reduce the amount of equipment using FERRUPS power and turn FERRUPS on again. If the problem persists, phone Best Power's Worldwide Service .
H	● ● ● ●	Hi Ambient Temp	The temperature inside the unit is too high. If the temperature reaches a preset point, the unit will shut down.	If the UPS has shut down, call Best Power's Worldwide Service . If not, shut down the protected equipment and FERRUPS, correct the cause of the high temperature if possible, and turn FERRUPS on again. If the problem persists, phone Best Power's Worldwide Service .
I	● ●	Hi Heatsink Temp	The inverter temperature is too high. If the temperature reaches a preset point, the UPS will shut down.	If the UPS has shut down, call Best Power's Worldwide Service . If not, shut down your equipment or bypass the UPS; turn the UPS off. Phone Best Power's Worldwide Service .
J	● - - -	User Test Alarm	The user is testing the alarm feature.	To start the user test alarm from the control panel, press [CONTROL] [8] [ENTER] [ENTER]. Repeat the procedure to turn the alarm off. (You can also use the alarmtest and alarmtest cancel commands. See Section 402 .)
K	- ● -	Hi Transfmr Temp	The transformer temperature is too high. If the temperature reaches a preset point, the UPS will shut down.	If the UPS has shut down, call Best Power's Worldwide Service . If not, shut down your equipment or bypass the UPS; turn off the UPS. Phone Best Power's Worldwide Service .
L	● - ● ●	Check Charger	The UPS has detected a charger problem.	Phone Best Power's Worldwide Service .

Letter	Audio Code	Alarm Message	What It Means	What To Do
M	--	Check Battery	The batteries have failed the automatic system test.	Phone Best Power's Worldwide Service .
N	- ●	Check Inverter	The inverter has failed the automatic system test.	Phone Best Power's Worldwide Service .
O	---	Memory Check	Possible microprocessor problem.	Shut down your equipment or bypass the UPS; turn the UPS off. Phone Best Power's Worldwide Service .
P	● -- ●	Emergency PwrOff	The Remote Shutdown feature has been activated at the RS232 port. (See Section 403.)	To restart the UPS, disconnect the signal to pin 21 on the RS232 port. If you have a control panel, put the FERRUPS in Auto Mode. If not, turn the On/Off switch off and then on again.
Q	-- ● -	Hi PFM Res Temp	The Power Factor Module's temperature is too high. If the temperature reaches a preset point, the UPS will shut down.	If the UPS has shut down, call Best Power's Worldwide Service . If not, shut down your equipment or bypass the UPS; then, turn the UPS off and call Best Power's Worldwide Service .
R	● - ●	Probe Missing	A temperature probe is missing or damaged.	The UPS may shut down. Call Best Power's Worldwide Service .
S	● ● ●	High AC Input	The input voltage is higher than the alarm setting.	Phone Best Power's Worldwide Service .
T	-	Call Service	The UPS has detected a problem that requires service.	The UPS will shut down. Call Best Power's Worldwide Service .

305 Parameter Table

The table on the next two pages shows the first 26 parameters. You can view or reset the parameters with a FERRUPS control panel or a terminal or computer ([Section 402](#)). Some of these parameters can keep track of information (like Time, Date, or the Alarm and Inverter Logs) or display operating and power conditions (like voltage, current or temperature). Other parameters (like User ID) let you program FERRUPS for special situations.

- If you plan to view or change parameters from the control panel, see [Section 302](#) for instructions.
- If you plan to view or change parameters from a terminal or computer that you have connected to the RS232 port, see the commands in [Section 402](#). When you use commands to display or change parameters, you can identify the parameter with either its number or name. (The table shows both.) If you use the name, you can enter the whole parameter name or just the short form shown in the table; you can also abbreviate the parameter name as long as your abbreviation includes the letters in the short form.

Although you do not need a password to view any of the first 26 parameters, many of them require a password to change. (See the Password column in the Parameter Table.) See [Section 302](#) or [402](#) for password information.

All changeable parameters except 0 (Time), 10 (Date), and 15 (Unit ID) are set at the factory. Only qualified service personnel using the proper metering equipment should change other parameters. Improper calibration may cause the FERRUPS to malfunction. Call [Best Power's Worldwide Service](#) before you attempt to change any parameters except 0, 10 and 15.

Number	Sample Display	Password	Terminal Name (Short Form)	Explanation
0	00 Time 07:04:00	User	time (t)	System Time. FERRUPS uses this time to record alarms and inverter runs. When the DC power has been off and you restart the unit, the time shown will be the last recorded time before shutdown. Reset time when DC power has been off.
1	01 V In 120.7	Service	acvoltsin (vi)	The input voltage FERRUPS is receiving. When this value drops below the brownout voltage, FERRUPS switches to inverter.
2	02 V Out 120.7	Service	acvoltsout (vo)	The voltage FERRUPS is providing to your equipment.
3	03 --Reserved--		Reserved	
4	04 I Out 6.2	Service	acampsout (o)	The current your equipment is drawing from FERRUPS.
5	05 VA Out 748	Change Not Allowed	vaout (va)	Volt-Amps Out. The total “apparent power” your equipment is drawing from FERRUPS. This value is based on parameter 2 multiplied by parameter 4, and should be less than or equal to the VA or kVA rating of your unit. See VALimit, parameter 19.
6	06 I Batt 0.0	Service	ibatt (ib)	Battery Current. When the UPS is running on AC input, this is the charging current in amps. When the UPS runs on battery power (inverter), this is the amount of current (in amps) the batteries are supplying to the unit.
7	07 V Batt 48.51	Service	vbatt (vb)	Battery Volts. The present battery voltage. FERRUPS will alarm if this value is too low.
8	08 Freq 60.43 Hz	Change Not Allowed	frequency (f)	During normal operation, this is the frequency of power FERRUPS is receiving from the AC input source. If this value falls outside preset limits, FERRUPS switches to battery power. When FERRUPS is running on battery power, this is the frequency FERRUPS is supplying to your equipment.
9	09 RunTime 12m	Change Not Allowed	runtime (rt)	Estimated Runtime Remaining. The amount of time FERRUPS will continue to support your equipment when the UPS is running on battery power. FERRUPS will alarm when this value falls below a preset limit.
10	10 Date 06/01/93	User	date (d)	System Date. FERRUPS uses this date to record alarms and inverter runs. The date must be reset when you restart the unit after DC power is turned off.
. or 11 ¹	11 Amb Temp 23c	Change Not Allowed	ambtemp (at)	The temperature (in Celsius) inside the unit. FERRUPS will alarm and shut down if this value is too high.
12	12 SinkTemp 26c	Change Not Allowed	heatsinktemp (st)	The temperature of the heatsink. FERRUPS will alarm if this value is too high.
13	13 --Reserved--		Reserved	

¹On a FERRUPS control panel, you can display the Ambient Temperature by pressing [DISPLAY] [.] [ENTER] or [DISPLAY] [1] [1] [ENTER].

Number	Sample Display	Password	Terminal Name (Short Form)	Explanation
14	14 XfmrTemp 28c	Change Not Allowed	xfmrtemp (xt)	The temperature of the transformer. FERRUPS will alarm and shut down if this value is too high. This parameter is not active on 850VA models; for these models, the display will always show -63c.
15	15 Unit ID Network #1 UPS	User	unitident (id)	Unit ID. An identification string that can be configured for use with your network.
16	16 FullLoad% 075	Change Not Allowed	fullload (l)	Percent of Full Load. The percentage of FERRUPS' total capacity that is actually being used by your equipment.
17	17 Watts 546	Change Not Allowed	watts (w)	The total "real power" your equipment is drawing from FERRUPS.
18	18 PF 0.73 Dist	Change Not Allowed	powerfact (pf)	The power factor of your equipment; the difference in the way it draws voltage and current. Power factor is equal to Watts Out (parameter 17) divided by VA Out (parameter 5). This parameter also tells whether the power factor is leading (Lead), lagging (Lag), or distortion (Dist).
19	19 VALimit 850	Change Not Allowed	valimit (val)	The maximum volt-amps FERRUPS can supply to your equipment at the present power factor. The unit will alarm when VA Out (parameter 5) is higher than this value.
20	20 #PwrOut 1	Change Not Allowed	powerout (po)	The number of times there has been a loss of input power since you started the unit.
21	21 #OvrLds 0	Change Not Allowed	overloads (ol)	The number of times FERRUPS has sensed an overload; that is, the number of times VA Out has been greater than VA Limit.
22	22 SysHrs 00000	Change Not Allowed	syshours (sh)	The total number of hours FERRUPS has been operating, regardless of mode. This number does not increase while the On/Off switch is turned off.
23	23 InvMin 0000.0	Change Not Allowed	invmin (im)	The total number of minutes the inverter has run since startup.
24	24 Inverter Log L 0319 2127 1215	Change Not Allowed	inverterlog (il)	A record of the date, time, duration and reason for the last 20 inverter (battery power) runs. (See Section 306.)
25	25 Alarm Log A 0319 2127 1215	Change Not Allowed	alarmlog (al)	A record of the date, time, duration and reason for the last 20 alarms. (See Section 306.)
26	26 Test Results (See explanation.)	Change Not Allowed	testresults (tr)	This parameter records the results of the last system test. The parameter display includes the time and date of the test and the results of each part of the system test. (See Section 303.)

Additional Parameters: The microprocessor in your FERRUPS keeps track of more than 100 parameters. Parameters 27 and above are alarm and operation set points, calibration factors and other settings. You usually do not need access to these parameters for normal operation of the FERRUPS. If you need information about the full range of FERRUPS parameters, call Best Power's Worldwide Service to ask for TIP 407 or TIP 503. TIP 407 describes communication from a control panel; TIP 503 describes communication through the RS232 port.

306 How to Read the Alarm and Inverter Logs

Your FERRUPS makes an entry in its logs every time it sounds an alarm or switches to inverter (battery power). This information can be helpful in diagnosing problems.

You can view the Alarm and Inverter Logs from either a FERRUPS control panel or a terminal or computer that you have connected to the RS232 port. (See [Section 400](#) to connect FERRUPS to a terminal or computer.)

Reading Logs from a Control Panel

Alarm Log: The Alarm Log is parameter 25. To display the Alarm Log from a control panel, follow these steps:

<u>PRESS THIS KEY:</u>	<u>DISPLAY SHOWS:</u>
[DISPLAY]	Display:
[2][5]	Display: 25
[ENTER]	25 Alarm Log

The display will then scroll through the 20 most recent entries in the Alarm Log. If you have not had 20 alarm conditions, the display will scroll through the entries FERRUPS has recorded. You can use the number keys as you view this scrolling display:

<u>USE THIS KEY:</u>	<u>TO DO THIS:</u>
[0]	Pause the scrolling and start it again.
[1] through [9]	Go to the next log entry.

Each log entry consists of four pieces of information: the alarm code, the date (month/day) of the alarm, the time (in 24-hour time) and the duration (in hours and minutes). For instance, one entry might look like this:

B 0205 1017 0005

In this example, “B” means the alarm was “Near Low Battery” (see Section 304 for more information on alarm codes); if alarm B was active, there would be an asterisk (*) after “B.” “0205” means the alarm occurred on February 5 (2/5). “1017” means the alarm occurred at 10:17 a.m. “0005” means the alarm condition lasted for 0 hours and 5 minutes.

Inverter Log: The Inverter Log is parameter 24. To display the Inverter Log, follow these steps:

<u>PRESS THIS KEY:</u>	<u>DISPLAY SHOWS:</u>
[DISPLAY]	Display:
[2][4]	Display: 24
[ENTER]	24 Inverter Log

The display will then scroll through the 20 most recent entries in the Inverter Log. If the inverter has not run 20 times, the display will scroll through the entries FERRUPS has recorded. You can use the number keys as you view this scrolling display:

<u>USE THIS KEY:</u>	<u>TO DO THIS:</u>
[0]	Pause the scrolling and start it again.
[1] through [9]	Go to the next log entry.

Each entry includes four pieces of information: the inverter code, the date (month/day) of the inverter run, the time (in 24-hour time) and the duration (in hours and minutes). For instance, one entry might look like this:

L 0205 0951 0015

In this example, “L” means the FERRUPS went to inverter because it lost AC input power; if the inverter was still running, there would be an asterisk (*) after the “L.” “0205” means the inverter ran on February 5 (2/5). “0951” means the inverter ran at 9:51 a.m. “0015” means the inverter ran for 0 hours and 15 minutes.

Here’s how to interpret the inverter codes:

Inverter Code	Meaning	Explanation
T	System Test	FERRUPS went to inverter to test the batteries.
B	Brownout	AC input voltage was too low.
L	Line Loss	AC input power was lost.
M	Manual	The inverter was started manually.
F	Frequency	Input frequency was too high or too low.
R	Reset	A system reset was performed.

Reading Logs from a Terminal or Computer

Alarm Log: To display the Alarm Log on a terminal or computer, you can use the **alarmlog** or **logs** command. (See [Section 402](#).) The Logs command displays both the Alarm and Inverter Logs.) These commands will display up to 20 log entries in a table. For example, the log might look like the table below:

<u>Active</u>	<u>EventDate</u>	<u>EventTime</u>	<u>Duration</u>	<u>Code/Event</u>
No	08/25/1993	11:25:32	00:00:45	J-User Test Alarm
No	08/24/1993	12:13:18	00:01:08	A-Low Battery
No	08/24/1993	12:05:07	00:08:11	B-Near Low Battery

The table shows whether the alarm is active now (Active), the date and time of each alarm, how long it lasted (Duration), and what caused the alarm (Code/Event).

You can also display parameter 25 to view the Alarm Log; this display is the same as the control panel display.

Inverter Log: To display the Inverter Log on a terminal or computer, you can use the **inverterlog** or **logs** command. (See [Section 402](#).) The Logs command displays both the Alarm and Inverter Logs.) These commands will display up to 20 log entries in a table. For example, the log might look like this:

<u>Active</u>	<u>EventDate</u>	<u>EventTime</u>	<u>Duration</u>	<u>Code/Event</u>
No	08/25/1993	11:25:32	00:00:45	M-Manual turnon
No	08/24/1993	12:13:18	00:01:08	L-Line fault

The table shows whether FERRUPS is running on inverter (battery power) now (Active), the date and time that FERRUPS ran on battery power, the length of time FERRUPS ran on battery power (Duration), and the reason (Code/Event).

You can also display parameter 24 to view the Inverter Log; this display is the same as the control panel display.

307 If You Have an Extended Power Outage

If your power is out for an extended time, your FERRUPS will continue to provide power for your equipment until it gets near the end of its runtime. You can check how much runtime you have left by reading parameter 9. (See [Section 305](#).) At a set number of minutes before the end of the runtime (factory default setting is five minutes), FERRUPS will sound a “Low Runtime” alarm (- ● ●). You should do an orderly shutdown of your equipment when you hear this alarm. Then, turn your FERRUPS off (see [Section 308](#)) to conserve the remaining battery power. When AC input power returns, turn FERRUPS on again so the batteries will recharge.

If your FERRUPS shuts itself down because its battery voltage is too low, shut FERRUPS off (see [Section 308](#)) until AC input power returns.

308 How (and When) to Shut Down Your FERRUPS

When to Shut Down Your FERRUPS

Your FERRUPS is designed for many years of round-the-clock operation. Usually, you do not need to shut down FERRUPS, even if your equipment will be shut down for several days. Even when it’s not powering your equipment, FERRUPS will monitor its internal condition and keep the Time and Date parameters current.

There will be some times, though, when you want to shut down FERRUPS, such as:

1. When you will not be using it for an extended time;
2. When it is being serviced;
3. Before you move it;
4. When it has gone into the Off Mode because the batteries have been discharged during an extended outage; or
5. When a system malfunction requires that you shut FERRUPS down.

How to Shut Down Your FERRUPS

CAUTION

To avoid possible equipment damage or personal injury, assume that there may be AC voltage at FERRUPS’ output terminals/receptacles any time AC input power or DC battery voltage is applied. FERRUPS can provide output voltage from the batteries even when there is no input line voltage. When AC input voltage is present, FERRUPS can provide output voltage even when the batteries are disconnected. If you want to be certain there is no UPS output voltage, always disconnect the AC input source and turn FERRUPS’ On/Off switch off; if you have a separate battery cabinet, you must also turn the DC switch to OFF or disconnect the battery connector.

1. Units with No Bypass Switch:

Turn off the protected equipment. If you need to use the equipment while the FERRUPS is off, connect the equipment to standard wall outlets (receptacles) and restart the equipment. Go to step 2.

Units with a Break-Before-Make Bypass Switch (see the label on the side of the switch):

Shut down your protected equipment; then, turn the bypass switch to “LINE.” Turn your equipment on again if you must use it while the UPS is off. Your equipment will receive direct AC line instead of conditioned power from the UPS. Go to step 2.

Units with a Make-Before-Break Bypass Switch (see the label on the side of the switch):

Make sure the AC Line light is on, the Battery Power light is off, and the UPS is providing output. If all three of these conditions are present, turn the bypass switch to “LINE.” If not, follow steps 2-4 below **before** you switch the bypass switch to “LINE”; there will be a break in power to your equipment after you have shut down your UPS and before you turn the bypass switch. Your equipment will receive direct AC line instead of conditioned power from the UPS.

2. Use the FERRUPS key to turn off its On/Off switch.
3. If your FERRUPS is plugged in, unplug it. If the UPS is not a plug-in model, turn off the AC Disconnect switch.
4. If your battery cabinet has a battery connector on the back, unplug the connector between the battery cabinet(s) and the UPS; **make sure you reconnect the battery connector before you start the UPS again.**

If your battery cabinet does not have a battery connector on the back, look for a hinged panel on top of the battery cabinet in one of the front corners. Unscrew the screw in that corner and lift the hinged panel; you should see the DC Switch. **You must turn the DC Switch off to make sure the batteries will not discharge.**

If your FERRUPS will be off for an extended time, recharge the batteries every 90-120 days. If you do not do this, the batteries may be damaged.

To turn power back on, follow the Startup procedure for your model in [Section 200](#). Make sure you complete all of the steps so the UPS will operate properly.

Section 400: Communication

This section describes FERRUPS' RS232 communication port and tells how to connect a terminal or computer to it to communicate with FERRUPS. It also describes the commands that you can enter from a terminal or computer. We'll also look at the other functions that you can access through the RS232 port: remote monitoring and remote shutdown.

Since FERRUPS is capable of full-duplex communication, it can communicate with a computer, a Local Area Network, or a multi-user computer system. If your system comes with UPS monitoring and automatic shutdown software, FERRUPS can communicate with that software. If your system does not have software, you can use the CheckUPS® II Suite power management software included with your FERRUPS. CheckUPS II does an orderly automatic shutdown of protected equipment and the UPS when there is a long power outage. CheckUPS II also provides UPS monitoring and control from your computer.

The diagram below shows the functions of the pins at FERRUPS' communication port.

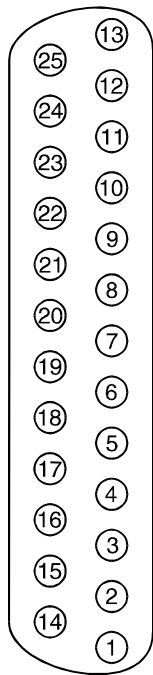

Pin	Description	
2	Transmit Data (In).	
3	Receive Data (Out).	
4	Request to Send.	To enable hardware handshaking on these pins, call your local Best Power office.
5	Clear to Send.	
6	+12 V Level (0.01 amp) when UPS is operating.	
7	Signal Ground.	
11	Contact opens when on inverter.	These relay contacts are rated at 25 V AC/DC and 250 mA. See Section 403 .
12	Contact closes when on inverter.	
13	Common Inverter Signal Contact.	
14	+12 V, 0.3 amp (850VA-3.1kVA) or 0.5 amp (4.3 and 7kVA). Do not use for setting logic levels.	
18	+12 V Level (0.01 amp) when the UPS is operating.	
20	AS/400 Option.	
21	Remote Shutdown.	
23	Contact closes on alarm.	These relay contacts are rated at 25 V AC/DC, 250 mA. Pins 23 and 25 change status when UPS is turned off. See Section 403 .
24	Common Alarm Signal Contact.	
25	Contact opens on alarm.	

Note that pins 2-5 and 7 are for RS232 communication, pins 11-13 and 23-25 are for remote monitoring, and pin 21 (used with 6 or 18) is for remote shutdown. The sections below will tell you more about how to take advantage of these features. Pin 20 is for option use only.

401 Connecting a Terminal or Computer to the RS232 Port

CAUTION

Do not make connections to the RS232 communication port if FERRUPS is connected to a positive ground battery system. The RS232 ground must be isolated or equipment damage will result. For help, call Best Power's Worldwide Service at 1-800-356-5737 or call your local [Best Power office](#).

If you are connecting a terminal to the RS232 port, the terminal must be capable of serial communications.

If you are connecting a computer, the computer must be running terminal emulation software. Terminal emulation programs are often included with your computer or a serial interface card. (For example, Windows® includes a terminal function — see the icon labeled “Terminal.”) Many popular modem software packages can emulate a terminal. If you do not have a terminal emulation program, please call Best Power's Worldwide Service for more information.

1. To connect FERRUPS' DB25S (female) RS232 port to your terminal or computer, you will need a cable designed specifically for this purpose. (See Figures 401-402.) Best Power offers cables for computers or terminals using 25-pin or 9-pin serial ports; call your local Best Power office to order one of these cables. If you would like to build your own cable, follow these requirements:

- Use a high-quality, shielded cable.
- **Do not use a standard 25-conductor straight-through cable;** you should only include straight-through connections for the pins shown in Figures 401-402. For RS232 communication, use pins 2 (transmit data), 3 (receive data), and 7 (signal ground); to use hardware handshaking (request to send on pin 4 and clear to send on pin 5), please call Best Power's Worldwide Service or your nearest [Best Power office](#). No other pins should be connected from FERRUPS' RS232 port to your terminal or computer.

For more information on pin connections and the function of the non-serial pins on the RS232 port, see the beginning of [Section 400](#) and [Section 403](#).

Note: To connect a modem, see TIP 503.

Computer DB9 to UPS

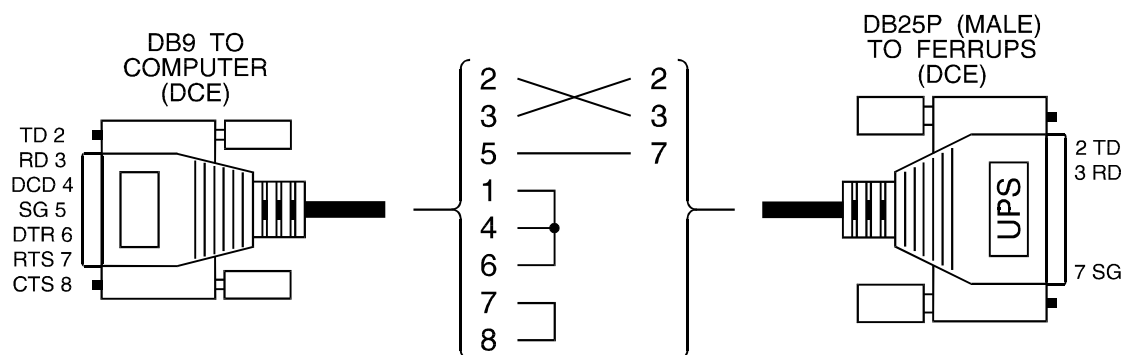

Figure 401

Computer DB25 to UPS

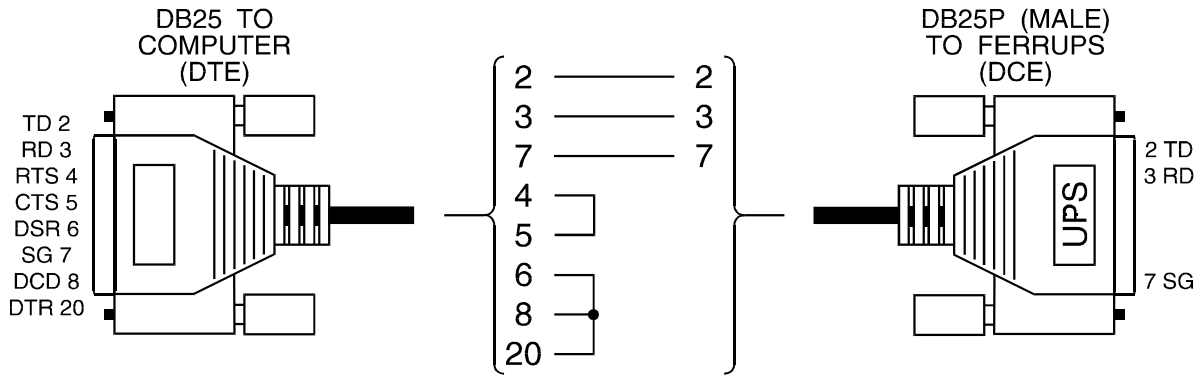

Figure 402

2. Connect the cable from the RS232 port on the back of the FERRUPS to the serial port on your terminal or computer.
3. Your terminal or computer should have these settings:
 - 1200 baud.
 - 8 data bits and 1 stop bit.
 - No parity.
 - FULL DUPLEX.

The terminal or terminal emulation software should also be set to FULL DUPLEX. If you are using a terminal, note that FERRUPS supports the Televideo 900 series, ADM3A and WYSE 50 emulation.

The table below shows the settings at FERRUPS' DB25S port. Call the nearest [Best Power office](#) if you need to adjust any of the settings.

Specification	Standard Setting	Adjustable to:
Connector	25 pin D (female) wired as DCE.	—
Format	ASCII. 8 data bits. 1 stop bit. Most significant bit set to 0.	Standard setting or 7/8 bits, ½ stop
Baud Rate	1200	50-38400
Parity	None	Odd, Even or None
Duplex	Full	Full or Half

4. Turn your terminal on or run your terminal emulation software. Then press the [ENTER] key on your **keyboard**. You should receive a message from FERRUPS, then a prompt. The prompt will vary depending on your current password level:

```

=>          Normal prompt
User=>      User Password has been entered
    
```

Press [ENTER] on your keyboard a few times to make sure FERRUPS responds.

5. To control or monitor FERRUPS, simply type the command you need and press [ENTER]. The table on the next page shows what keystrokes you can use as you type commands or view displays. See [Section 402](#) for more information on FERRUPS commands.

To do this	Use this key sequence
Delete last character typed.	[BACKSPACE] or [CTRL]-[H]
Delete line.	[CTRL]-[X]
Pause displays that take more than one screen.	[CTRL]-[S]
Resume scrolling. (Turn Pause off.)	[CTRL]-[Q]

402 Entering Commands from a Terminal or Computer

To monitor or control FERRUPS from a terminal or computer, simply type in one of the commands and press [ENTER]. (See the table below.) You can type the command in uppercase or lowercase, and you can use the whole command or the short form, or you can abbreviate the command as long as you include the letters in the short form. You can also enter more than one command on a line if you put a semicolon between commands. You will need to enter the User Password before FERRUPS will accept some commands; use the **password** command below to do this. (The User Password is 377.)

Command	Short Form	Password	Function
alarmshelp	ah	None	Shows a list of all possible alarm messages, the audio code and letter for each alarm and whether the alarm is active.
alarmlog	al	None	Displays Alarm Log. See Section 306 .
alarmtest	at	None	Allows you to test the alarm function. Alarmtest sounds the User Test alarm (J). See Section 304 .
alarmtest cancel	at c		Turns the User Test alarm off.
chargermode	chm	None ²	Shows the FERRUPS' battery charger mode. By entering a mode after the chargermode command, you can change the charger mode: chargermode off (chm f) or chargermode disable (chm d) = charger off; chargermode on (chm o) or chargermode enable (chm e) = charger on; chargermode auto (chm a) = charger enabled if AC input voltage and battery voltage are acceptable.
clearalarms	ca	None	Clears all active alarms.
clearhistory	ch	None	Clears the minimum and maximum parameter values shown when you use the extendedhistory or history commands.
clearpassword	cp	None	Clears the current password.
commands	cm	None	Displays a list of all valid commands.
contdisplay	cd	Depends on parameter password	Continuously displays the parameter that you are currently displaying. You can specify other parameters for the continuous display by entering the name or number of each parameter after the contdisplay command.
contstatus	cs	None	Continuously displays the Status information. (See the status command.)

²If you change parameter 39 to "Yes," this command requires the User password.

Command	Short Form	Password	Function
date	da	None	Displays system time and date. To set the date, enter date [month]/[day]/[year] .
delay	dl	None	Delays next command when you enter a number after delay . Each unit represents 2.5 milliseconds, so delay 1 would cause a 2.5 mS delay. For a 1-second delay, enter delay 400 .
display	d	Depends on parameter password	Displays the values of one or more parameters. (See Parameter Table, Section 305 .) Format: display [parameter # or name] [parameter # or name] Example: d 1 fullload ol will display the values of parameters 1, 16, and 21.
extendedhistory	xh	None	Displays the minimum and maximum values of parameters 1 (AC Volts In), 2 (AC Volts Out), 7 (DC Volts), and 5 (VA Out); the command then clears the minimum and maximum values. See the Parameter Table, Section 305 .
format	f	None	Displays an 80-character line containing information on the FERRUPS' status. CheckUPS II Suite power management software and other UPS monitoring software use this data.
help	? or he	None	Shows a list of terminal/computer commands.
history	h	None	Displays the minimum and maximum values of parameter 1 (AC Volts In); the command then clears the minimum and maximum values.
identify	I	None	Shows Best Power's address and telephone number and the software version.
inverterlog	il	None	Displays the Inverter Log. See Section 306 .
logs	l	None	Displays both the Alarm and Inverter Logs. See Section 306 .
message "[message]"	m	None	Displays a message (up to 16 characters) on the control panel. The control panel will continue to display the message until a control panel key is pressed.
off [time]	o [time]	None ³	Shuts down FERRUPS in a given number of seconds. The READY LED will blink until the UPS shuts down, and the UPS will beep five seconds before shutdown. Example: OFF 60 shuts down the unit in 60 seconds.
off [time] autostart	o [time] a	None ⁴	Shuts down FERRUPS in a given number of seconds (see above), and restarts the UPS shortly after power returns.
off cancel	o c	None ⁴	Cancels timed shutdown.
parameters	p	Depends on parameter password	Shows a list of system parameters. See Section 305 . You can also display a range of parameters by entering the starting and ending parameter number or name after the command. Example: Parameters 1 10 will display parameters 1 through 10.
paramkeywords	pk	Depends on parameter password	Displays all parameters and their keywords (the names you can use with commands). You can also display a range of parameters by entering the numbers or names of the starting and ending parameters.

³If you change parameter 39 to "Yes," this command requires a User password.

Command	Short Form	Password	Function
password	pw	None	Allows you to enter the User Password. Typing password alone clears the current password. Example: password 377 enters the User Password.
program	pr	Depends on parameter password	Lets you set the value of any parameter. You must enter the appropriate password before you reset the value. See the password command above. Format: PR [parameter # or name] [newvalue] Example: PR 0 815 resets the time (parameter 0) to 8:15 a.m.
remote	rm	None	Configures the RS232 port so the connected terminal will work like a control panel.
shutdown or shutdown autostart	sd sd a	None ⁴	Shuts down the UPS output in 60 seconds (if you enter shutdown alone) or the number of seconds you specify after the command. If you specify autostart , the UPS will restart shortly after power returns. The READY LED will blink until the UPS shuts down.
shutdown cancel	sd c		Cancels a shutdown started with the shutdown command.
shutup	sh	None	Turns off audible alarm.
status	s	None	Shows date, time, system status, present system mode, active alarms, and the value of various system parameters.
systemmode _	sm	None ⁵	Typing systemmode alone displays which system mode is now active. You can use systemmode with a , o , I , or l to enter one of the modes below.
systemmode auto	sm a		Enters the Auto Mode. This is the normal FERRUPS mode. In this mode, FERRUPS is conditioning AC input power for your equipment; if there is a power outage, FERRUPS is ready to switch to battery power.
systemmode off	sm f		Enters the Off Mode. In this mode, FERRUPS is not providing power to your equipment, but you can still use FERRUPS' control panel.
systemmode inverter	sm I		Enters the Inverter Mode. In this mode, FERRUPS is converting DC battery power to AC power for your equipment.
systemmode linecondition	sm l		Enters the Line Condition Mode. In this mode, FERRUPS is conditioning AC input power for your equipment, but it will not switch to battery power (inverter) if there is a power outage; instead, FERRUPS will sound a Low AC Out alarm.
systemtest	stst	None ⁵	Starts a system test of the logic, inverter and battery.
time	t	None	Shows the current UPS time. To set the time, enter [hour]:[minutes] after the command.
unshutup	u	None	Turns audible alarm back on.

⁴If you change parameter 39 to "Yes," this command requires a User password.

403 Remote Monitoring and Remote Shutdown

Monitoring

Alarm Signal Contacts: These are relay contacts (rated at 25V AC/DC and 250 mA) that change status on any alarm condition or when the UPS is turned off. (See the beginning of [Section 400](#).) Contacts that close on an alarm are available between pins 23 and 24. Contacts that open on an alarm are available between pins 24 and 25.

Inverter On Signal Contacts: These are relay contacts (rated at 25V AC/DC and 250 mA) that change status when the inverter turns on. (See the beginning of [Section 400](#).) Contacts that close on inverter operation are available between pins 12 and 13. Contacts that open on inverter operation are available between pins 11 and 13.

Remote Shutdown

FERRUPS can be connected to a remote shutdown switch to shut off output from the UPS to your protected equipment. The shutdown switch must have a set of contacts that can apply FERRUPS' +12 VDC on pin 6 to FERRUPS' pin 21. (You can use pin 18 instead of pin 6; **do not use pin 14**.) Use a shielded, single twisted pair cable to connect the switch to the FERRUPS' pins. A brief connection between pins 6 and 21 (or 18 and 21) will shut down FERRUPS' output power to the protected equipment. When FERRUPS' Remote Shutdown feature has been activated, FERRUPS will be in the OFF Mode, and the Emergency Power Off Alarm will sound. A control panel or a terminal connected to the FERRUPS will display "Emergency PwrOff." To restart the UPS after a Remote Shutdown, break the connection between pins 6 and 21 (or between pins 18 and 21) at FERRUPS' RS232 port. Then, follow the steps in the Startup section for your model (202 or 203). Note that the 12-volt level on pin 6 or pin 18 is only available when FERRUPS is operating.

You can change the type of signal that FERRUPS responds to and how quickly FERRUPS responds. You can also set up FERRUPS to restart automatically when the shutdown signal stops. See TIP 503 or call Best Power's [Worldwide Service](#) for more information.

Section 500: Maintenance and Service

In this section, we'll look at the kind of maintenance your FERRUPS needs and how to contact Best Power's [Worldwide Service](#).

501 Regular Maintenance

Best Power designed your FERRUPS to provide years of trouble-free operation. Its microprocessor will check the batteries and inverter regularly to assure you of proper operation. In fact, you'll probably find that your FERRUPS requires less maintenance than any of your other computer peripherals.

Nevertheless, your FERRUPS does require some attention in order to provide you with excellent service. Best Power recommends that you schedule a Preventative Maintenance check at least every six months. At this check, your service technician should

- Inspect and clean the unit.
- Inspect and record the Alarm and Inverter Logs.
- Check the batteries.
- Check the AC and DC meter functions and recalibrate if necessary.
- Perform an outage test.
- Check the values of the first 19 parameters on line and inverter.

Your technician must observe important safety precautions while performing these checks. For more information on what your technician should do in a Preventative Maintenance check, or to schedule Preventative Maintenance with a Best Power-authorized field service representative, call Best Power's [Worldwide Service](#). We'll be happy to help you.

502 Service and Support

Best Power has an outstanding customer service department. Please feel free to call, write, or fax the nearest Best Power office if you have a problem or question about your FERRUPS. **Please have your model number and serial number when you call.** This information appears on a label at the rear of your unit. You also can get this information by reading parameter 40 on the control panel. If you are requesting repair under warranty, please include proof of purchase and purchase date in correspondence. Call Best Power for instructions before returning a unit or component. (See the beginning of this manual for other [Best Power offices](#).)

In the U.S.A.:
Worldwide Service
Best Power
Route 1, Box 106 - P.O. Box 11
Necedah, Wisconsin 54646 U.S.A.

Phone: 1-800-356-5737 (U.S.A. and Canada)
1-608-565-2100

Fax: 1-608-565-2509

Section 600: Specifications

This section provides technical information about the FERRUPS physical and operating specifications.

601 Specification Table: Standard Product

Model	850VA/ 600W	1.15kVA/ 800W	1.4kVA/ 1kW	1.8kVA/ 1.25kW	2.1kVA/ 1.5kW	3.1kVA/ 2.2kW	4.3kVA/ 3kW	7kVA/ 5kW
AC Input Voltage*	120	120	120	120	120	120	120**/ 208/240	120**/ 208/240
60 Hz								
50 Hz	220/230/ 240	220/230/ 240	220/230/ 240	220/230/ 240	220/230/ 240	220/230/ 240	220/230/ 240	220/230/ 240
AC Input Current, Standard Charger	6.6 amps	8.5 amps	11 amps	16 amps	19 amps	25 amps	32 amps	51 amps
FES/FER:	120	3.7 amps	5.0 amps	6.0 amps	9.2 amps	11 amps	14 amps	18 amps
208	3.2 amps	4.2 amps	5.3 amps	8.2 amps	9.2 amps	12 amps	16 amps	26 amps
240								
QFES/QFER:	220	4.4 amps	4.9 amps	5.7 amps	7.9 amps	8.2 amps	13 amps	19 amps
220	4.2 amps	4.6 amps	5.4 amps	7.5 amps	7.8 amps	12 amps	18 amps	26 amps
230	4.0 amps	4.4 amps	5.2 amps	7.2 amps	7.4 amps	12 amps	17 amps	24 amps
240								
Recommended AC Input Service for 60 Hz Models with 120 VAC**	10 amp	15 amp	15 amp	20 amp	25 amp	35 amp	40 amp	70 amp
Output Voltage and Maximum Output Current in amps***	120=7.0 220=3.8 230=3.6 240=3.5	120=9.3 220=5.0 230=4.8 240=4.7	120=11 220=6.4 230=6.2 240=5.9	120=15 220=7.9 230=7.6 240=7.3	120=17 220=9.3 230=8.9 240=8.6	120=26 220=14 230=13 240=13	120=34 208=20 220=19 230=18 240=17	120=58 208=34 220=31 230=30 240=29
Efficiency on AC Line	85%	88%	88%	90%	90%	91%	90%	90%
On Line BTU/hr: kW/hr:	361 0.106	372 0.109	465 0.136	474 0.139	568 0.166	742 0.217	1138 0.333	1896 0.556
Audible Noise (dB)	48	50	50	50	50	51	50	52
Runtime (in min.)****								
Full Load:	11	19	14	31 (9)	24 (7)	14	26	12
Half Load:	28	49	36	73 (23)	58 (18)	35	61	33

* Other voltages are available. Call the nearest Best Power office for more information.

** 120 VAC is **optional** for FER4.3kVA and FER7kVA models.

*** At 0.7 leading power factor.

**** Numbers in () are for FES and QFES models. Standard runtimes are shown; optional extended runtimes are available.

602 AC Output with Nominal Input Power and Loads (Protected Equipment)

- Voltage Regulation:* FERRUPS provides $\pm 3\%$ load regulation. Total voltage regulation under any line, load, or battery condition to within -8.3% and $+5\%$ of nominal. Exceeds CBEMA and ANSI voltage regulation standard for computing equipment.
- Overload Capability:* On line (nominal AC volts in) — 150% surge and 125% for 10 minutes. On inverter (nominal DC volts in) — 150% surge and 110% for 10 minutes. Overload operation is not thermally limited. FERRUPS' microprocessor continuously monitors output VA and sounds an alarm before loss of output voltage regulation occurs.
- Sine-wave Power:* FERRUPS provides sine-wave, computer-grade power with five percent or less total harmonic distortion at rated load. It meets or exceeds CSA C22.2 No. 107.1.
- Output Frequency:* On line: 60 Hz (FES or FER) or 50 Hz (QFES or QFER) with nominal power line grid stability of ± 0.005 Hz.
- On inverter: 60 Hz (FES or FER) or 50 Hz (QFES or QFER) ± 0.005 Hz. Output frequency tracks input line frequency up to limit, which is adjustable from ± 0.01 Hz to ± 3.00 Hz. Inverter turns on if line frequency exceeds the selected limit.

603 Lightning and Surge Protection

FERRUPS provides 2000-to-1 spike attenuation. Tested using lightning standard per ANSI/IEEE C62.41 Category A (6000 volt spike and 200 amp) and Category B (6000 volt spike and 3000 amp) test, and ANSI/IEEE C62.45 test procedures.

604 Isolation and Noise Rejection

- Isolation, Including Output Neutral to Ground Bonding:* FERRUPS provides a true separately derived power source, as defined by National Electrical Code Article 250-5d, with output neutral bonded to ground. There is no direct connection between input and output, and less than 2 pF of effective input to output capacitance.
- Noise Rejection:* Common Mode: greater than 120 dB with output neutral bonded to ground. Transverse (Normal) Mode: greater than 60 dB.

605 Environment

- Storage Temperature:* Batteries: -20° to $+40^{\circ}$ Celsius (-4° to 104° F). See [Section 201](#).
UPS: -20° to $+60^{\circ}$ Celsius (-4° to 140° F) if batteries are removed from the UPS.
- Relative Humidity:* 0 to 95% without condensation.
- Operating Ambient Temperature:* 0° to 40° Celsius (32° to 104° F) and 95% relative humidity.

Ventilation Requirement: Clean, dust-free air, free of corrosive chemicals or other contaminants must be available. FERRUPS uses internal fans to circulate the air for cooling. Air must be free to circulate around the UPS and battery cabinet(s).

High Altitude Operation: The maximum operating ambient temperature drops 1 ° C per 300 meters (2 ° F per 1000 feet) above sea level, with the maximum elevation being 3000 meters (10,000 feet).

606 Protection

DC Input: DC fuse and battery charger fuse.

Output Protection: The ferroresonant transformer inherently limits current and provides overload protection. FERRUPS has high AC and low AC output voltage alarms, as well as an overload alarm. If the AC output voltage falls below the low AC output voltage alarm setpoint, the unit will alarm after five seconds. If the AC output voltage falls below the low AC output **shutdown** setpoint, the unit will alarm **and shut down**.

Some FERRUPS models have output receptacles protected by fuses or circuit breakers.

607 Batteries and Battery Charger

Standard batteries are sealed, gas recombinant, lead-acid type, especially designed for UPS use.

850VA to 1.4kVA: Nominal battery voltage is 12 VDC. The standard battery charger output is variable. For 850VA units, the charger output is rated at approximately 4 amperes at low battery and 2 amperes at 13.7 VDC. For 1.15kVA and 1.4kVA units, the charger output is rated at approximately 8 amperes at low battery and 2 amperes at 13.7 VDC.

1.8kVA to 3.1kVA: Nominal battery voltage is 48 VDC. The standard battery charger is rated at 4 amperes at 54.8 VDC.

4.3kVA to 7kVA: Nominal battery voltage is 48 VDC. The standard battery charger is rated at 5 amperes.

Optional battery chargers at higher current ratings are available. Call the nearest [Best Power office](#) for more information.

608 Dimensions and Weights

Dimensions

Model	Dimensions (H x W x D)
FES/QFES 850VA, 1.15kVA 1.4kVA, 1.8kVA, and 2.1kVA	Unit: 9.75 in. x 16 in. x 21.25 in. (248 mm x 406 mm x 540 mm) Front Panel: 10.5 in. high x 19 in. wide (267 mm high x 483 mm wide)
FER/QFER 1.8kVA, 2.1kVA, and 3.1kVA	Unit: 9.75 in. x 16 in. x 26.25 in. (248 mm x 406 mm x 667 mm) Front Panel: 10.5 in. high x 19 in. wide (267 mm high x 483 mm wide)
FER/QFER 4.3kVA and 7kVA	Unit: 19 in. x 16 in. x 26.25 in. (483 mm x 406 mm x 667 mm) Front Panel: 19.25 in. high x 19 in. wide (489 mm high x 483 mm wide)
RBC-1, RBC-2 Battery Cabinets	Cabinet: 13.5 in. x 17 in. x 26.5 in. (343 mm x 432 mm x 673 mm) Front Panel: 14 in. high x 19 in. wide (356 mm high x 483 mm wide)
RBC-3 Battery Cabinets	Cabinet: 8.3 in. x 16.25 in. x 24.25 in. (211 mm x 413 mm x 616 mm) Front Panel: 8.8 in. high x 19 in. wide (224 mm high x 483 mm wide)

Weights

60 Hz Models

Model	Weight without Battery	Weight with Battery	Battery Cabinet with Standard Batteries
FES850VA	79 lbs./36 kgs.	105 lbs./48 kgs.	—
FES1.15kVA	83 lbs./38 kgs.	135 lbs./62 kgs.	—
FES1.4kVA	98 lbs./45 kgs.	150 lbs./68 kgs.	—
FES1.8kVA FER1.8kVA	96 lbs./44 kgs. 105 lbs./48 kgs.	152 lbs./69 kgs. 209 lbs./95 kgs.	—
FES2.1kVA FER2.1kVA	106 lbs./48 kgs. 116 lbs./53 kgs.	162 lbs./74 kgs. 220 lbs./100 kgs.	—
FER3.1kVA	138 lbs./63 kgs.	238 lbs./108 kgs.	—
FER4.3kVA	245 lbs./111 kgs.	—	250 lbs./113.4 kgs.
FER7kVA	330 lbs./150 kgs.	—	250 lbs./113.4 kgs.

50 Hz Models

Model	Weight without Battery	Weight with Battery	Battery Cabinet with Standard Batteries
QFES850VA	37 kgs.	49 kgs.	—
QFES1.15kVA	40 kgs.	64 kgs.	—
QFES1.4kVA	47 kgs.	70 kgs.	—
QFES1.8kVA QFER1.8kVA	49 kgs. 51 kgs.	72 kgs. 98 kgs.	—
QFES2.1kVA QFER2.1kVA	54 kgs. 56 kgs.	77 kgs. 103 kgs.	—
QFER3.1kVA	66 kgs.	111 kgs.	—
QFER4.3kVA	118 kgs.	—	113.4 kgs.
QFER7kVA	158.8 kgs.	—	113.4 kgs.

Section 700: Warranty

LIMITED TWO YEAR WARRANTY Standard Warranty For All Purchases

BEST POWER, a division of General Signal Power Systems, Inc. (hereinafter called BEST POWER) warrants that each product sold by BEST POWER is compatible with existing commercially available computer equipment with enclosed power supplies and is free from defects in materials and workmanship under normal use and service. This warranty is applicable only to the initial retail purchaser (PURCHASER), and is not transferable. The duration of this warranty is two (2) years from the date of the first retail sale or the date of delivery to the PURCHASER, whichever occurs first, subject to the following conditions.

If the PURCHASER discovers within the duration of this warranty a failure of the product to perform compatibly with presently existing computer equipment or a defect in material or workmanship, the PURCHASER must promptly notify BEST POWER in writing within the duration of the warranty or not later than one month after expiration of the warranty. BEST POWER's obligation under this warranty is limited to the replacement or repair, subject to the conditions specified below, of such product returned intact to BEST POWER which shall appear to BEST POWER, upon inspection, to have been either incompatible or defective. Replacement or repair will be made at BEST POWER's Worldwide Service, Highway 80, Necedah, Wisconsin 54646, U.S.A. Such repair or replacement shall be at BEST POWER's expense. This warranty does not cover any taxes which may be due in connection with replacement or repair, nor any installation, removal, transportation or postage costs. These expenses will be paid by PURCHASER. If BEST POWER is unable to repair or replace the product to conform to this warranty after a reasonable number of attempts, BEST POWER will refund the purchase price. Remedies under this warranty are expressly limited to those specified above.

TO THE EXTENT ALLOWED BY LAW, BEST DISCLAIMS ALL OTHER WARRANTIES, EXPRESS OR IMPLIED, INCLUDING, BUT NOT LIMITED TO, ANY IMPLIED WARRANTIES OF MERCHANTABILITY OR FITNESS FOR A PARTICULAR PURPOSE, AND ANY IMPLIED WARRANTY OF MERCHANTABILITY OR FITNESS FOR A PARTICULAR PURPOSE ON THIS PRODUCT IS LIMITED IN DURATION TO THE DURATION OF THIS WARRANTY. TO THE EXTENT ALLOWED BY LAW, BEST POWER SHALL NOT BE LIABLE FOR ANY SPECIAL, INCIDENTAL, OR CONSEQUENTIAL DAMAGES INCLUDING, BUT NOT LIMITED TO, LOSS OF PROFITS, INJURIES TO PROPERTY, LOSS OF USE OF THE PRODUCT OR ANY ASSOCIATED EQUIPMENT.

Some states do not allow limitations on how long an implied warranty lasts, so that the above limitation on duration of implied warranties may not apply to you. Some states do not allow the exclusion or limitation of incidental or consequential damages, so the above limitation or exclusion may not apply to you. This warranty gives you specific legal rights, and you may also have other rights which vary from state to state. You are advised to consult applicable state laws.

No warranty is made with respect to other products sold by BEST POWER which do not bear the name BEST POWER, and no recommendation of such other product shall imply or constitute any warranty with respect to them. This warranty does not cover repair or replacement because of damage from unreasonable use (for example only, damage from road hazard, accident, fire or other casualty, misuse, negligence, or incorrect wiring) and any use or installation not in conformance with instructions furnished by BEST POWER, or repairs or replacements needed because of modifications or parts not authorized or supplied by BEST POWER.

LIMITED WARRANTY
Transient Voltage Surge Suppression Circuitry
(For U.S. and Canadian Purchasers Only)

BEST POWER, a division of General Signal Power Systems, Inc. ("BEST POWER") hereby warrants the transient voltage surge suppression circuitry in each FERRUPS®, FORTRESS®, PATRIOT®, UNITY/I™, CITADEL®, or SPIKEFREE™ product (hereinafter called "Product") sold by it for installation in the United States of America and Canada to be free from defects in material and workmanship under normal use and service for the lifetime of the Product, beginning with the date of sale to the initial retail purchaser, subject to the following conditions. This warranty is applicable only to the initial retail purchaser (hereinafter called PURCHASER), is not transferable, and is limited to the following remedies:

1. The replacement or repair of the transient voltage surge suppression circuitry in each Product that is returned intact to BEST POWER and which shall appear to BEST POWER upon inspection to have been defective in material or workmanship or to have been damaged through normal use;
2. The reimbursement to the PURCHASER of up to \$25,000 per occurrence of documented physical damage to specified computer equipment connected to a Product where such damage could have been prevented by transient voltage surge suppression circuitry as detailed in BEST POWER's specification for the Product sold.

This warranty is made in addition to BEST POWER's Limited Two Year Warranty.

This warranty does not include any taxes which may be due in connection with replacement or repair nor any installation, transportation or postage costs. These expenses will be paid by PURCHASER. Replacement or repair will be made at BEST POWER's Worldwide Service, Highway 80, Necedah, Wisconsin 54646, U.S.A.

This warranty does not cover repair or replacement because of damage from unreasonable use (damage from road hazards, accident, fire or other casualty, misuse, negligence, incorrect wiring) and any use or installation not in conformance with instructions furnished by BEST POWER, or repairs or replacements needed because of modifications or parts not authorized or supplied by BEST POWER.

This warranty is operable only upon the written acceptance by BEST POWER of an application by the PURCHASER on BEST POWER's standard form for the above warranty coverage for the Product sold. In such application, the PURCHASER shall represent that the Product sold has been properly installed and grounded in accordance with instructions received from BEST POWER, and the PURCHASER shall also specify the computer equipment to which the Product sold has been connected and the location of the computer equipment. This warranty will not apply to any equipment not specified in the application by the PURCHASER as protected equipment.

EXCEPT AS EXPRESSLY SET FORTH IN THIS WARRANTY AND BEST POWER's LIMITED TWO YEAR WARRANTY, BEST POWER MAKES NO OTHER WARRANTIES, AND TO THE EXTENT ALLOWED BY LAW, BEST DISCLAIMS ALL OTHER WARRANTIES, EXPRESS OR IMPLIED, INCLUDING, BUT NOT LIMITED TO, ANY IMPLIED WARRANTIES OF MERCHANTABILITY OR FITNESS FOR A PARTICULAR PURPOSE.

REMEDIES UNDER THIS WARRANTY ARE EXPRESSLY LIMITED TO THE REPAIR OR REPLACEMENT OF PRODUCTS AND THE REIMBURSEMENT SPECIFIED ABOVE, AND TO THE EXTENT ALLOWED BY LAW ANY CLAIMS FOR LOSS ARISING OUT OF THE FAILURE OF PRODUCTS TO PERFORM FOR ANY PERIOD OF TIME, OR SPECIAL, INDIRECT, INCIDENTAL OR CONSEQUENTIAL DAMAGES OR OTHER ECONOMIC LOSS ARE EXPRESSLY EXCLUDED.

Some states do not allow limitations on how long an implied warranty lasts, so that the above limitation on duration of implied warranties may not apply to you. Some states do not allow the exclusion or limitation of incidental or consequential damages, so the above limitation or exclusion may not apply to you. This warranty gives you specific legal rights, and you may also have other rights which vary from state to state. You are advised to consult applicable state laws.

Section 800: Options

Best Power offers many options for your FERRUPS. The list below describes these options; if you would like more information, contact your local Best Power office or dealer.

Bypass Switches: If your UPS does not have a plug, a bypass switch lets you transfer your protected equipment to direct AC input power conveniently when it's time to service your FERRUPS. Your local Best Power office can tell you if a bypass switch is recommended for your UPS and describe the different bypass switches.

Control Panel: Best Power offers Control Panels and extension cables that let you monitor and operate FERRUPS from a remote location.

Environmental Monitoring: Best Power's EnviroCom™ monitors many office and UPS conditions and phones you when there is a problem. EnviroCom II also lets you 1) phone your FERRUPS for an update on its status and environment, and 2) control and communicate with your FERRUPS through a modem.

Extended Runtimes: If you want extended runtimes, call Best Power for information on adding additional battery capacity or an optional battery charger.

Interface Kits: For computers that include their own UPS monitoring and shut down software, Best Power offers interface cable kits for use between your UPS and the computer. Kits are available for Novell NetWare, IBM AS/400, Windows NT/LAN Manager/LAN Server, Lantastic, and Banyan VINES.

Plugs, 60 Hz: The following plugs are available for 60 Hz units **with a standard battery charger**. Optional plugs are also available for FER4.3kVA and FER7kVA models.

Unit	120 VAC	208 VAC	240 VAC
FES850VA, FES1.15kVA, FES1.4kVA	5-15P	6-15P	6-15P
FER1.8kVA, FER2.1kVA	5-20P	6-15P	6-15P
FER3.1kVA	L5-30P	L6-20P	L6-20P

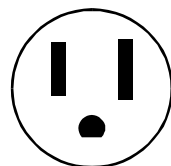

5-15P

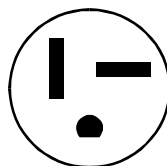

5-20P

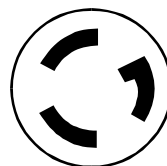

L5-30P

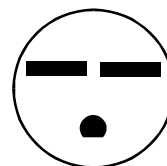

6-15P

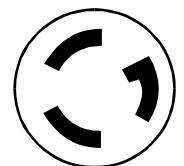

L6-20P

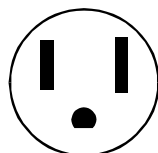

5-50P



L6-30P

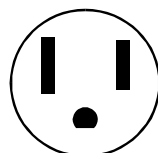

6-50P



L14-30P

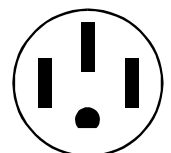

14-50P

Receptacles:

The following output receptacles are available when you order a new unit:

60 Hz RECEPTACLE OPTIONS											
120 VOLT						120/240 VOLT*					
A 120V 15A		B 120V 20A		CD 120V 20A		C 120V 15A		E 120V 20A		F 120V 30A	
5-15R		5-20R		5-20R		L5-15R		L5-20R		L5-30R	
208/240 VOLT											
G 208/240V 20A		H 208/240V 30A		K 208/240V 15A		L 208/240V 15A		M 208/240V 20A			
L6-20R		L6-30R		6-15R		L6-15R		6-20R			

*208 volts not available with L14-20R or 30R.

50 Hz RECEPTACLES						
IEC 320* 10A 250V	QA EUROPEAN 10/16A 250V	QB UNITED KINGDOM 10A 250V	QC SWISS 10A 250V	QD ITALIAN 10A 250V	QF AUSTRALIAN 10A 250V	QG FRENCH 10/16A 250V

*IEC 320 receptacles are only available for QFES850VA to QFER3.1kVA models.

Warranties:

Besides our standard two-year warranty, Best Power offers several Warranty Enhancement Plans to meet your service and maintenance needs. Contact the nearest [Best Power office](#) for more information.

For Users in the United States Only

This equipment has been tested and found to comply with the limits for a Class A digital device, pursuant to Part 15 of the FCC rules. These limits are designed to provide reasonable protection against harmful interference when the equipment is operated in a commercial environment. This equipment generates, uses, and can radiate radio frequency energy and, if not installed and used in accordance with the instruction manual, may cause harmful interference to radio communications. Operation of this equipment in a residential area is likely to cause harmful interference in which case the user will be required to correct the interference at his/her own expense.

For Users in Canada

This digital apparatus does not exceed the Class A limits for radio noise emissions from digital apparatus set out in the Radio Interference Regulations of the Canadian Department of Communications.

We hereby certify that the uninterruptible power system (QFES 850VA, 1.15kVA, 1.4kVA, 1.8kVA, and 2.1kVA; QFER 1.8kVA, 2.1kVA, 3.1kVA, 4.3kVA, and 7kVA) complies with the RFI suppression requirements of Vfg. 243/1991 and Vfg. 46/1992. The German Postal Service was notified that the equipment is being marketed. The German Postal Service has the right to retest the equipment and verify compliance.

Hiermit wird bescheinigt, daß die unterbrechungsfreie Stromversorgung (QFES 850VA, 1.15kVA, 1.4kVA, 1.8kVA, und 2.1kVA; QFER 1.8kVA, 2.1kVA, 3.1kVA, 4.3kVA, und 7kVA) in Übereinstimmung mit den Bestimmungen der Vfg. 243/1991 und Vfg. 46/1992 funktentstört ist.

Der Deutschen Bundespost wurde das Inverkehrbringen dieses Gerätes angezeigt und die Berechtigung zur Überprüfung der Serie auf Einhaltung der Bestimmung eingeräumt.

Best Power reserves the right to change specifications without prior notice.

ALARM AUDIO CODE

A ●—	Low Battery	K —●—	High Transformer Temp
B —●●●	Near Low Battery	L ●—●●	Check Charger
C —●—●	High Battery	M — —	Check Battery
D —●●	Low Runtime	N —●	Check Inverter
E ●	Low AC Output	O — — —	Memory Check
F ●●—●	High AC Output	P ●— —●	Emergency Power Off
G — —●	Output Overload	Q — —●—	High PFM Temp
H ●●●●	High Ambient Temp	R ●—●	Probe Missing
I ●●	High Heatsink Temp	S ●●●	High AC Input
J ●— — —	User Test Alarm	T —	Call Service



Best Power

P.O. Box 280 - Necedah, Wisconsin 54646 U.S.A.

Telephone 1-608-565-7200

Sales Toll-Free 1-800-356-5794 (U.S.A. and Canada)

Service Toll-Free 1-800-356-5737 (U.S.A. and Canada)

World Wide Web Site: <http://www.bestpower.com>

Fax on Demand: 1-800-487-6813