

VER	DATE	UPDATE	APP'D
A	2011/05/23	release	
B	2011/06/28	remove "EATON ePDU" LOGO on bottom	

05

- Part Number.....ePBZ91
- Mounting.....Horizontal (1U)
- Over Current Protection.....CB-2P/20A x 2 (UL489) TAISHIBA
- Power Switch.....N/A
- Rating.....24A / 240 Vac
- Input.....NEMA L6-30P
- Outlet.....IEC320 C13 x 10
- Power Cord.....10AWG / 3C, 10FT
- UL Standard.....UL60950-1
- Certification.....UL

change outlet No. to from back cover to front cover

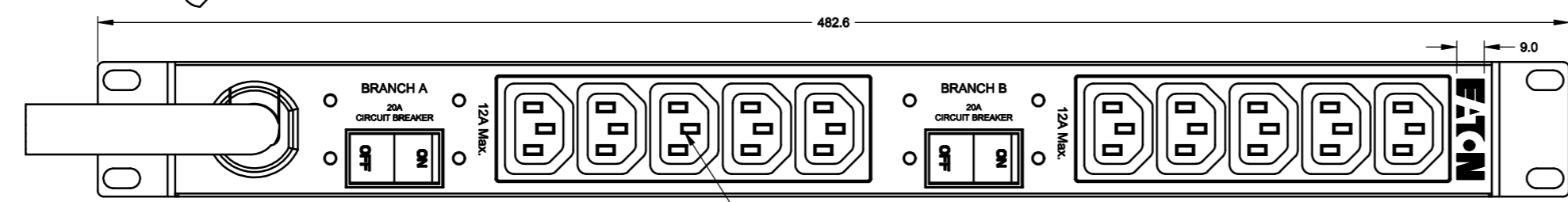
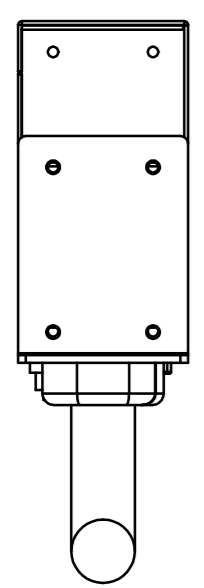
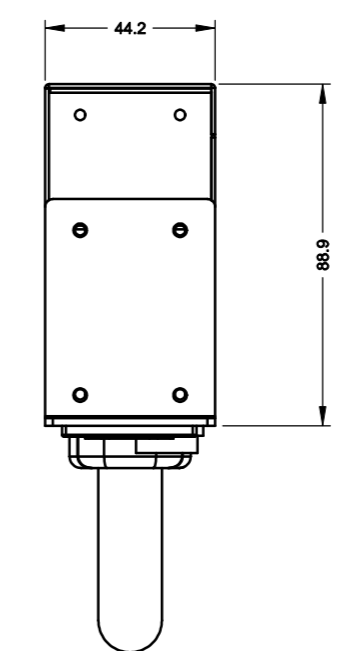
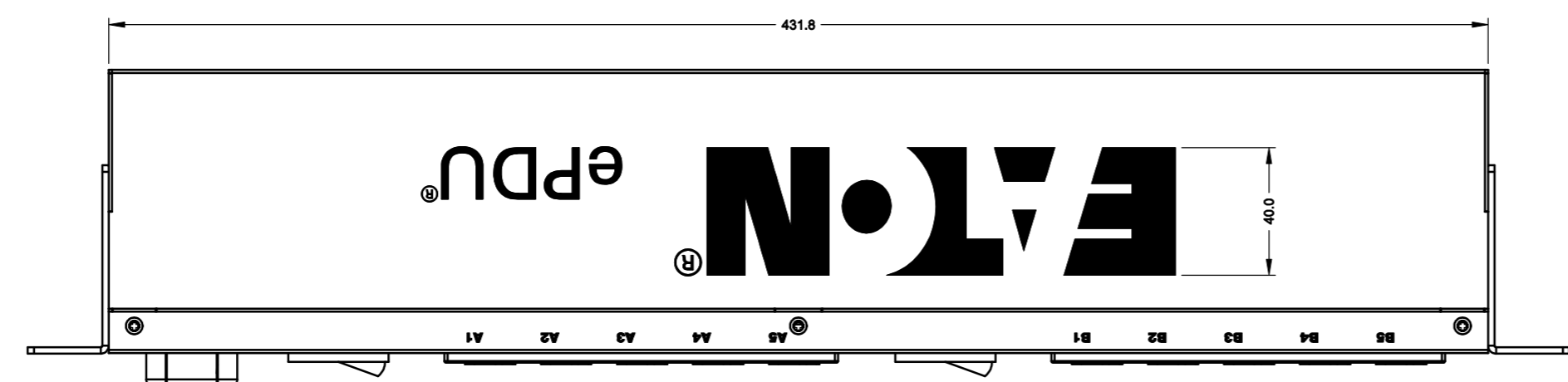
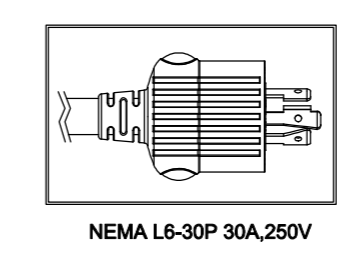
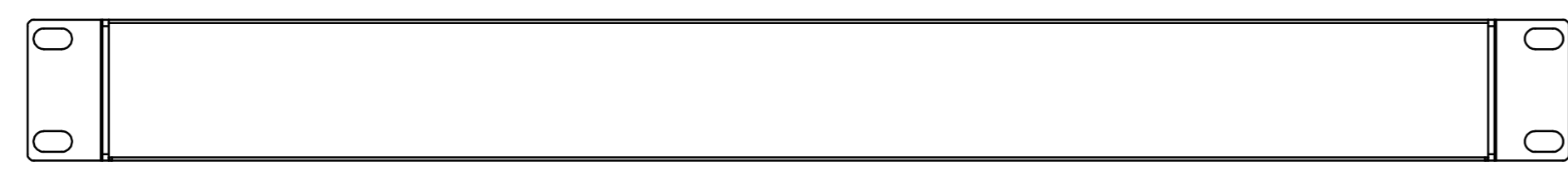
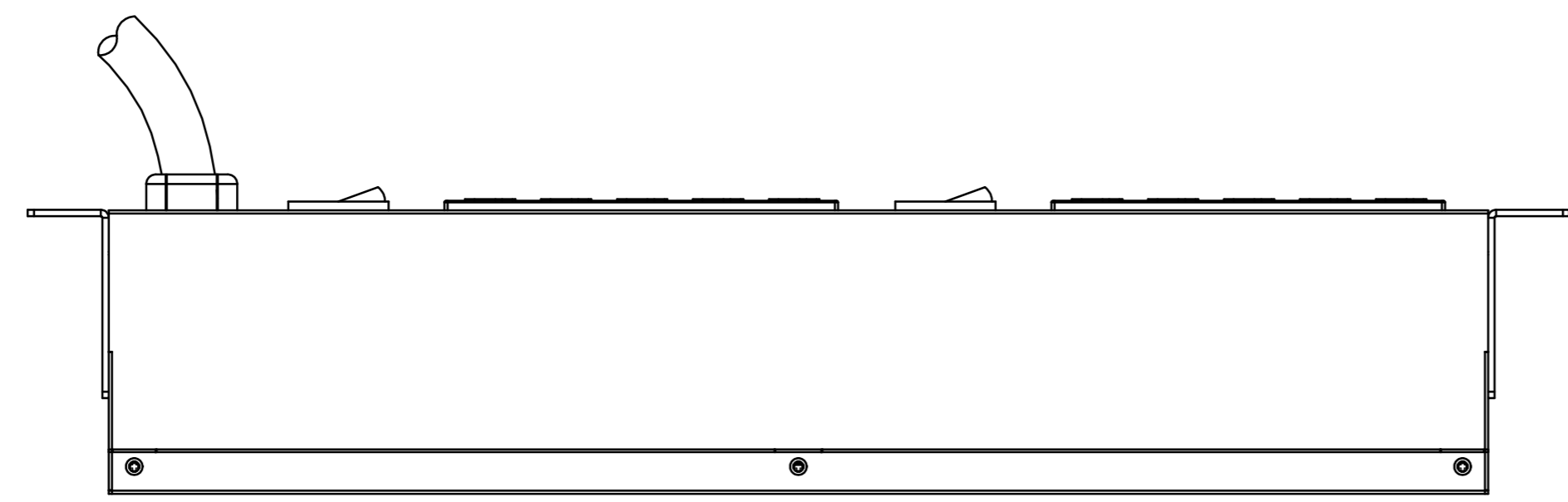

screw hole for bush button

NOTE: all dimension for reference only.



Size:	A2	NAME	DATE	DIMENSION TOLERANCE	MATERIAL	
DRAWN	TYC	2011/05/23	X±0.3 mm	see Note	EPBZ91-APR	
CHECKED	TYC	2011/05/23	.X±0.1 mm			
APP'D	JSL	2011/05/23	.XX±.05 mm	SHEET	PART NO:	R217-
SCALE:	1:2	VERSION:	B	X'± 1°	1 OF 1	DRAW NO: R217